

REFERENCE

SPEC. No. ED-07G005
ISSUE Mar 1, 2007

SHARP

OPTO-ANALOG DEVICES DIVISION
ELECTRONIC COMPONENTS GROUP
SHARP CORPORATION

SPECIFICATION

DEVICE SPECIFICATION FOR

MODEL No.

PHOTO INTERRUPTER

REFERENCE

GP1S56TJ000F

Specified for _____

Enclosed please find copies of the Specifications which consists of 10 pages including cover.
This specification sheets and attached sheets shall be both side copy.

After confirmation of the contents, please be sure to send back copies of the Specifications
with approving signature on each.

CUSTOMER'S APPROVAL

PRESENTED

DATE

DATE

BY

BY H. O

H. Ogura,
Department General Manager of
Engineering Dept., III
Opto-Analog Devices Div.
ELECOM Group
SHARP CORPORATION

Product name : PHOTOINTERRUPTER

Model No. : GP1S56TJ000F

1. These specification sheets include materials protected under copyright of Sharp Corporation ("Sharp"). Please do not reproduce or cause anyone to reproduce them without Sharp's consent.
2. When using this product, please observe the absolute maximum ratings and the instructions for use outlined in these specification sheets, as well as the precautions mentioned below. Sharp assumes no responsibility for any damage resulting from use of the product which does not comply with the absolute maximum ratings and the instructions included in these specification sheets, and the precautions mentioned below.

(Precautions)

- (1) This product is designed for use in the following application areas ;

(• OA equipment • Audio visual equipment • Home appliances
 • Telecommunication equipment (Terminal) • Measuring equipment
 • Tooling machines • Computers)

If the use of the product in the above application areas is for equipment listed in paragraphs (2) or (3), please be sure to observe the precautions given in those respective paragraphs.

- (2) Appropriate measures, such as fail-safe design and redundant design considering the safety design of the overall system and equipment, should be taken to ensure reliability and safety when this product is used for equipment which demands high reliability and safety in function and precision, such as ;

(• Transportation control and safety equipment (aircraft, train, automobile etc.)
 • Traffic signals • Gas leakage sensor breakers • Rescue and security equipment
 • Other safety equipment)

- (3) Please do not use this product for equipment which require extremely high reliability and safety in function and precision, such as ;

(• Space equipment • Telecommunication equipment (for trunk lines)
 • Nuclear power control equipment • Medical equipment)

- (4) Please contact and consult with a Sharp sales representative if there are any questions regarding interpretation of the above three paragraphs.

3. Please contact and consult with a Sharp sales representative for any questions about this product.

1. Application

This specification applies to the outline and characteristics of transmissive type photointerrupter, Model No. GP1S56TJ000F.

2. Outline

Refer to the attached drawing No. CY13796i02.

3. Ratings and characteristics

Refer to the attached sheet, Page 5 to 6.

4. Reliability

Refer to the attached sheet, Page 7.

5. Outgoing inspection

Refer to the attached sheet, Page 8.

6. Supplements

6.1 Parts

Refer to the attached sheet, Page 9.

6.2 ODS materials

This product shall not contain the following materials.

Also, the following materials shall not be used in the production process for this product.

Materials for ODS : CFCs, Halon, Carbon tetrachloride, 1,1,1-Trichloroethane (Methylchloroform)

6.3 Specified brominated flame retardants

Specified brominated flame retardants (PBB and PBDE) are not used in this device at all.

6.4 Product mass : Approx. 0.38g

6.5 Compliance with each regulation

6.5.1 The RoHS directive(2002/95/EC)

This product complies with the RoHS directive(2002/95/EC) .

Object substances: mercury, lead, cadmium, hexavalent chromium, polybrominated biphenyls (PBB) and polybrominated diphenyl ethers (PBDE)

6.5.2 Content of six substances specified in Management Methods for Control of Pollution Caused by Electronic Information Products Regulation (Chinese : 电子信息产品污染控制管理办法).

Category	Toxic and hazardous substances					
	Lead (Pb)	Mercury (Hg)	Cadmium (Cd)	Hexavalent chromium (Cr(VI))	Polybrominated biphenyls (PBB)	Polybrominated diphenyl ethers (PBDE)
PHOTOINTERRUPTER	✓	✓	✓	✓	✓	✓

✓ : indicates that the content of the toxic and hazardous substance in all the homogeneous materials of the part is below the concentration limit requirement as described in SJ/T 11363-2006 standard .

6.6 Country of origin : Japan, Indonesia

7. Notes

7.1 Circuit design

In circuit designing, make allowance for the degradation of the light emitting diode output that results from long continuous operation. (50% degradation/5 years)

7.2 Position of opaque board

Opaque board shall be installed at place 3mm or more from the top of elements.

(Example)

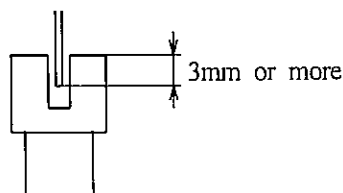

7.3 Soldering

To solder onto lead pins, solder at 260°C for 5 seconds or less.

Please take care not to let any external force exert on lead pins when soldering or just after soldering.

Please don't do soldering with preheating, and please don't do soldering by reflow.

7.4 Cleaning conditions :

(1) Solvent cleaning : Solvent temperature 45°C or less

Immersion 3 min. or less

(2) Ultrasonic cleaning : The effect to device by ultrasonic cleaning differs by cleaning bath size, ultrasonic power output, cleaning time, PCB size or device mounting condition etc. Please test it in actual using condition and confirm that doesn't occur any defect before starting the ultrasonic cleaning.

(3) Applicable solvent : Ethyl alcohol, Methyl alcohol, Isopropyl alcohol

7.5 Flux

Some flux, which is used in soldering, may crack the package due to synergistic effect of alcohol in flux and the rise in temperature by heat in soldering. Therefore, in using flux, please make sure that it does not have any influence on appearance and reliability of the photointerrupter.

2. Outline

(Drawing No.CY13796i02)

Scale: 2/1 Unit: 1/1mm

1) Unspecified tolerances shall be followed the list below.

Dimension	Tolerance
$d \leq 6$	± 0.1
$6 < d \leq 18$	± 0.2

2) Dimensions in parenthesis are shown for reference.

3) Model No. and Sharp mark, Date code: Mark in the case

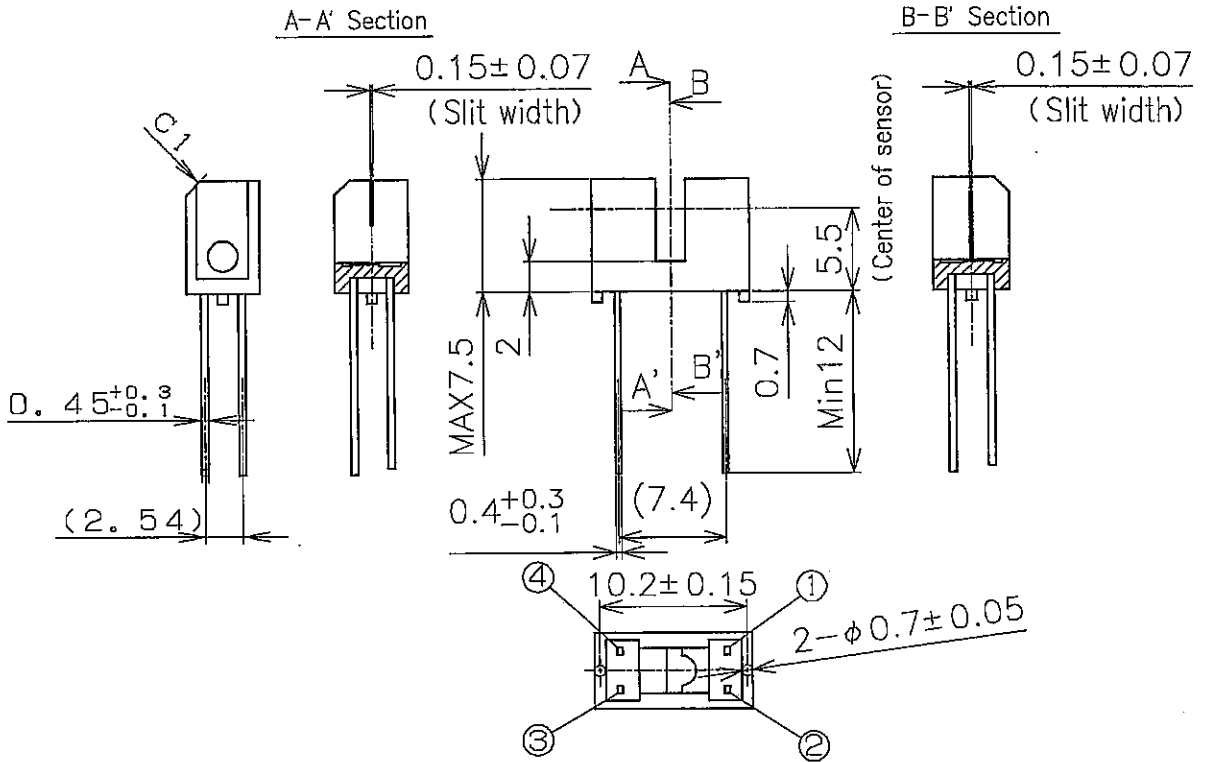
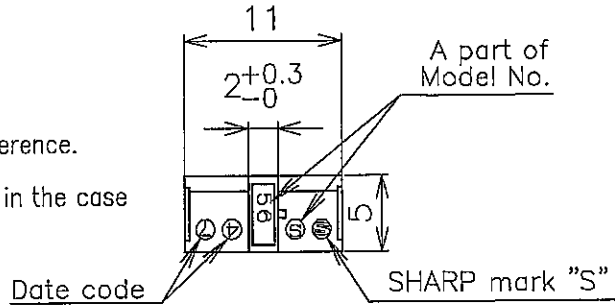

Internal connection diagram

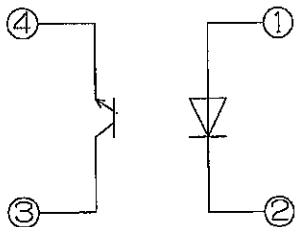

- ① Anode
- ② Cathode
- ③ Collector
- ④ Emitter

3. Ratings and characteristics

3.1 Absolute maximum ratings

Ta=25°C

Parameter		Symbol	Rating	Unit
Input	*1 Forward current	I _F	50	mA
	*1, 2 Peak forward current	I _{FM}	1	A
	Reverse voltage	V _R	6	V
	Power dissipation	P	75	mW
Output	Collector-emitter voltage	V _{CEO}	35	V
	Emitter-collector voltage	V _{ECO}	6	V
	Collector current	I _c	20	mA
	*1 Collector power dissipation	P _c	75	mW
Operating temperature		Topr	-25 to +85	°C
Storage temperature		Tstg	-40 to +100	°C
*3	Soldering temperature	Tsol	260	°C

- *1 The derating factors of absolute maximum ratings due to ambient temperature are shown in Fig. 1, 2, 3.
- *2 Pulse width ≤ 100 μs, Duty ratio : 0.01
- *3 For 5s

3.2 Electro-optical characteristics

Ta=25°C

Parameter	Symbol	Conditions	MIN.	TYP.	MAX.	Unit	
Input	Forward voltage	V _F	I _F =20mA	-	1.2	1.4	V
	Peak forward voltage	V _{FM}	I _{FM} =0.5A	-	3	4	V
	Reverse current	I _R	V _R =3V	-	-	10	μA
Output	Dark current	I _{CEO}	V _{CE} =20V	-	1	100	nA
Transfer characteristics	Collector current	I _c	V _{CE} =5V, I _F =20mA	0.4	-	-	mA
	Collector-emitter saturation voltage	V _{CE(sat)}	I _F =40mA, I _c =0.25mA	-	-	0.4	V
	Response time (Rise)	tr	V _{CE} =2V, I _c =0.5mA	-	38	90	μs
	Response time (Fall)	tf	R _L =1kΩ	-	48	110	μs

(Test circuit for response time)

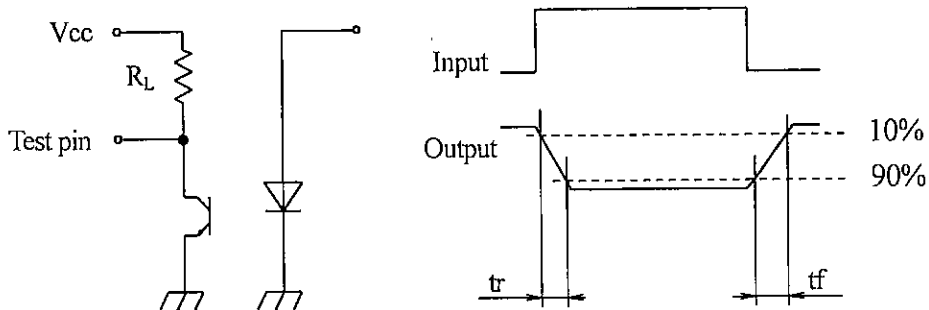

Fig.1 Forward current vs. ambient temperature

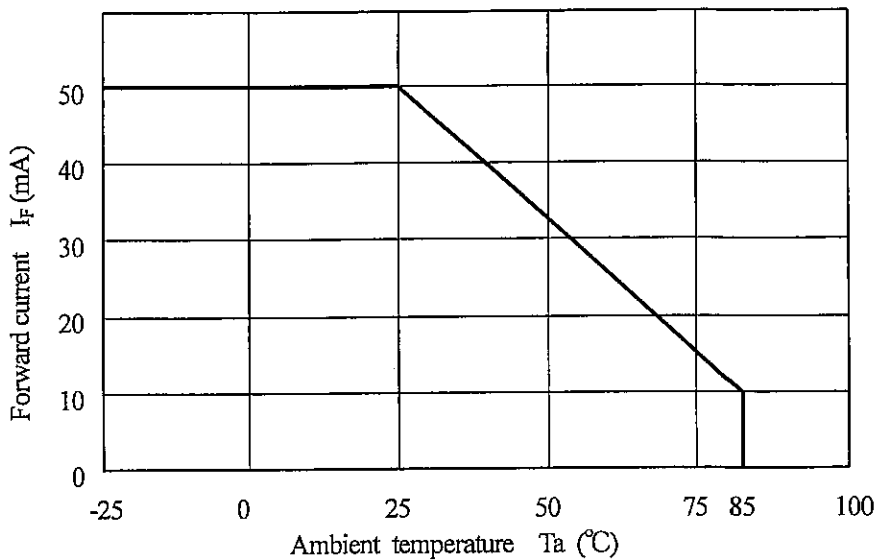

Fig.2 Collector power dissipation vs. ambient temperature

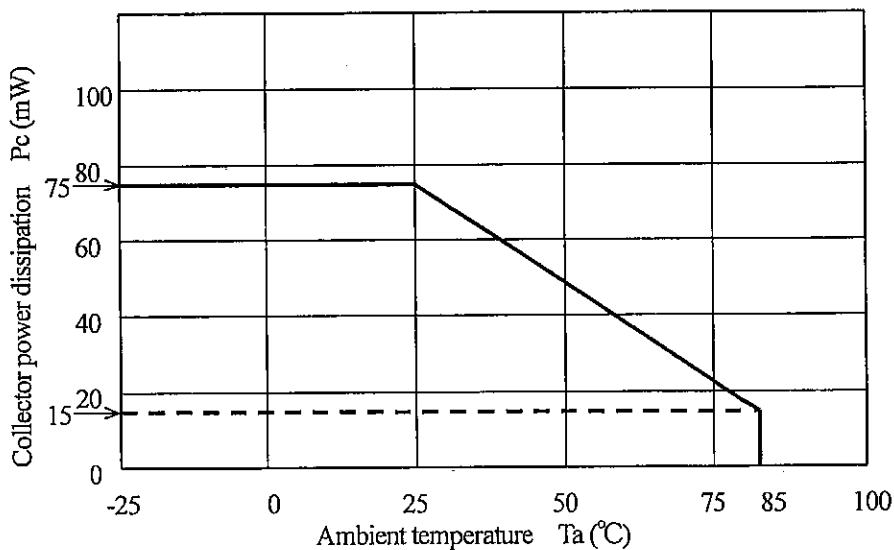
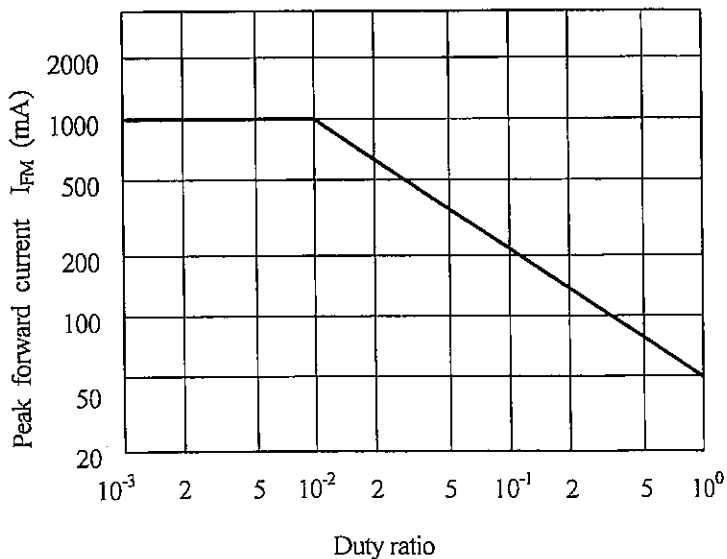

Fig.3 Peak forward current vs. duty ratio



(Pulse width $\leq 100 \mu s$ $T_a = 25^\circ C$)

4. Reliability

The reliability of products shall be satisfied with items listed below.

Confidence level : 90%

LTPD : 10 or 20

Test Items	Test Conditions	Failure Judgement Criteria	Samples (n)
			Defective (c)
Temperature cycling	1 cycle -40°C to +100°C (30min.) (30min.) 20 cycle test	$V_F \geq U \times 1.2$ $I_R \geq U \times 2$ $I_c \leq L \times 0.8$ $I_{CEO} \geq U \times 2$ U: Upper specification limit L: Lower specification limit	n=22, c=0
High temp. and high humidity storage	+60°C, 90%RH, 500h		n=22, c=0
High temp. storage	+100°C, 500h		n=22, c=0
Low temp. storage	-40°C, 500h		n=22, c=0
Operation life	$I_F=20\text{mA}$, $T_a=25^\circ\text{C}$, 500h		n=22, c=0
Mechanical shock	15000m/s ² , 0.5ms 3times/±X, ±Y, ±Z direction		n=11, c=0
Variable frequency vibration	100 to 2000 to 100Hz/20min. 2h/X, Y, Z direction 100m/s ²		n=11, c=0
Terminal strength (Tension)	Weight: 10N · 30s/each terminal		n=11, c=0
Terminal strength (Bending) *1	Weight: 5N 0° →90° →0° →-90° →0° 1 time bending		n=11, c=0
Soldering heat	260°C, 5 s		n=11, c=0
Solderability *2	245°C, 5 s	Judgement only appearance Solder shall adhere at less than 95% area of immersed portion of lead.	n=11, c=0

*1 Terminal bending direction is shown below.

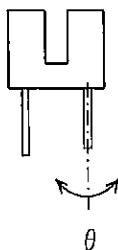

*2 The alloy composition of solder used should be Sn-3.0Ag-0.5Cu.

Flux used for precleaning should be equivalent to EC-19S(TAMURA KAKEN CORPORATION).

5. Outgoing inspection

5.1 Inspection items

(1) Electro-optical characteristics

V_F , V_{FM} , I_R , BV_{CEO} , BV_{ECO} , I_{CEO} , I_C , $V_{CE(sat)}$

(2) Appearance

5.2 Sampling method and Inspection level

A single sampling plan, normal inspection based on ISO 2859 is applied.

Defect	Inspection item	Inspection level	AQL(%)
Major defect	Characteristics defect Unreadable marking	II	0.065
Minor defect	Appearance defect except the above mentioned.	II	0.25



6. Supplements

6.1 Parts

This product uses the below parts.

6.1.1 Light detector (PT480, Quantity : 1)

Type	Material	Maximum sensitivity wavelength (nm)	Sensitivity wavelength (nm)	Response time (μ s)
Phototransistor	Silicon (Si)	800	400 to 1200	3

6.1.2 Light emitter (GL480, Quantity : 1)

Type	Material	Maximum light emitting wavelength (nm)	I/O Frequency (MHz)
Infrared light emitting diode (non-coherent)	GaAs	950	0.3

6.1.3 Material

Case	Lead flame finish
Black NORYL resin	Solder dip (Sn-3.0Ag-0.5Cu)

6.1.4 Others

This product shall not be radiation flux proof.