

PREPARED BY:	SHARP	SPEC No. LD-23903B
APPROVED BY:		FILE No.
		ISSUED: Jul. 23, 2012
		PAGE : 25 pages
	SHARP CORPORATION SPECIFICATION	APPLICABLE GROUP Display Device Business Group

DEVICE SPECIFICATION FOR
TFT-LCD module
 MODEL No. LQ043Y1DX07

These parts have corresponded with the RoHS directive.

CUSTOMER'S APPROVAL

DATE _____

BY _____

PRESENTED

BY *J. Kawanishi*

J. Kawanishi
 Department general manager
 Development Department I
 Display Device Division II
 Display Device Business Group
 SHARP CORPORATION

NOTICE

- These specification sheets are the proprietary product of SHARP CORPORATION (SHARP) and include materials protected under copyright of SHARP. Do not reproduce or cause any third party to reproduce them in any form or by any means, electronic or mechanical, for any purpose, in whole or in part, without the express written permission of SHARP.
- The application examples in these specification sheets are provided to explain the representative applications of the device and are not intended to guarantee any industrial property right or other rights or license you to use them. SHARP assumes no responsibility for any problems related to any industrial property right of a third party resulting from the use of the device.
- The device listed in these specification sheets was designed and manufactured for use in Telecommunication equipment (terminals)
- In case of using the device for applications such as control and safety equipment for transportation (aircraft, trains, automobiles, etc.), rescue and security equipment and various safety related equipment which require higher reliability and safety, take into consideration that appropriate measures such as fail-safe functions and redundant system design should be taken.
- Do not use the device for equipment that requires an extreme level of reliability, such as aerospace applications, telecommunication equipment (trunk lines), nuclear power control equipment and medical or other equipment for life support.
- SHARP assumes no responsibility for any damage resulting from the use of the device which does not comply with the instructions and the precautions specified in these specification sheets.
- Contact and consult with a SHARP sales representative for any questions about this device.

[For handling and system design]

- (1) Do not scratch the surface of the polarizer film as it is easily damaged.
 - (2) If the cleaning of the surface of the LCD panel is necessary, wipe it swiftly with cotton or other soft cloth. Do not use organic solvent as it damages polarizer.
 - (3) Water droplets on polarizer must be wiped off immediately as they may cause color changes, or other defects if remained for a long time.
 - (4) Since this LCD panel is made of glass, dropping the module or banging it against hard objects may cause cracks or fragmentation. Liquid crystal contained in the panel may leak if the LCD is broken. Rinse it as soon as possible if it gets inside your eye or mouth by mistake.
 - (5) When handling LCD modules and assembling them into cabinets, that long-terms storage in the environment of oxidization or deoxidization gas and the use of such materials as reagent, solvent, adhesive, resin, etc. which generate these gases, causes corrosion and discoloration of the modules. Therefore, please avoid these use. Epoxy resin (amine series curing agent), silicone adhesive material (dealcoholization series and oxime series), tray forming agent (azo compound) etc, in the cabinet or the packing materials may induce abnormal display with polarizer film deterioration regardless of contact or noncontact to polarizer film.
- Check carefully that gas from materials used in system housing or packaging do not hart polarizer. Be sure to confirm the component of them.

(6) Liquid crystal material will freeze below specified storage temperature range and it will not get back to normal quality even after temperature comes back within specified temperature range. Liquid crystal material will become isotropic above specified temperature range and may not get back to normal quality. Keep the LCD module always within specified temperature range.

(7) Do not expose LCD module to the direct sunlight or to strong ultraviolet light for long time.

(8) If the LCD driver IC (COG) is exposed to light, normal operation may be impeded. It is necessary to design so that the light is shut off when the LCD module is mounted.

(9) Do not disassemble the LCD module as it may cause permanent damage.

(10) As this LCD module contains components sensitive to electrostatic discharge, be sure to follow the instructions in below.

① Operators

Operators must wear anti-static wears to prevent electrostatic charge up to and discharge from human body.

② Equipment and containers

Process equipment such as conveyer, soldering iron, working bench and containers may possibly generate electrostatic charge up and discharge. Equipment must be grounded through 100Mohms resistance. Use ion blower.

③ Floor

Floor is an important part to leak static electricity which is generated from human body or equipment. There is a possibility that the static electricity is charged to them without leakage in case of insulating floor, so the countermeasure (electrostatic earth: $1 \times 10^8 \Omega$) should be made.

④ Humidity

Proper humidity of working room may reduce the risk of electrostatic charge up and discharge. Humidity should be kept over 50% all the time.

⑤ Transportation/storage

Storage materials must be anti-static to prevent causing electrostatic discharge.

⑥ Others

Protective film is attached on the surface of LCD panel to prevent scratches or other damages. When removing this protective film, remove it slowly under proper anti-ESD control such as ion blower.

(11) Hold LCD very carefully when placing LCD module into the system housing. Do not apply excessive stress or pressure to LCD module. Do not to use chloroprene rubber as it may affect on the reliability of the electrical interconnection.

(12) Do not hold or touch LCD panel to flex interconnection area as it may be damaged.

(13) As the binding material between LCD panel and flex connector mentioned in 12) contains an organic material, any type of organic solvents are not allowed to be used. Direct contact by fingers is also prohibited.

(14) When carrying the LCD module, place it on the tray to protect from mechanical damage. It is recommended to use the conductive trays to protect the CMOS components from electrostatic discharge. When holding the module, hold the Plastic Frame of LCD module so that the panel, COG and other electric parts are not damaged.

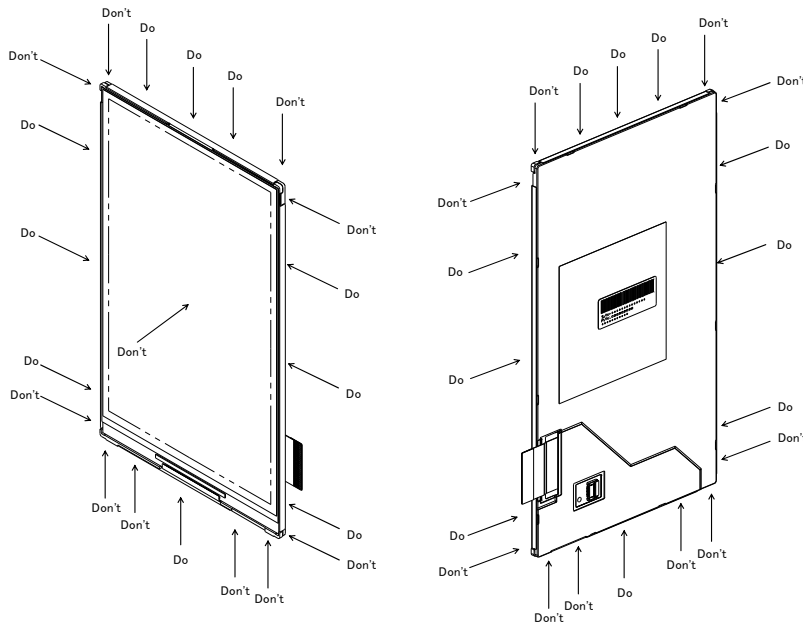

- (15) Do not touch the COG's patterning area. Otherwise the circuit may be damaged.
- (16) Do not touch LSI chips as it may cause a trouble in the inner lead connection.
- (17) Place a protective cover on the LCD module to protect the glass panel from mechanical damages.
- (18) LCD panel is susceptible to mechanical stress and even the slightest stress will cause a color change in background and pooling. So make sure the LCD panel is placed on flat plane without any continuous twisting, bending or pushing stress.
- (19) Protective film is placed onto the surface of LCD panel when it is shipped from factory. Make sure to peel it off before assembling the LCD module into the system. Be very careful not to damage LCD module by electrostatic discharge when peeling off this protective film. Ion blower and ground strap are recommended.
- (20) Make sure the mechanical design of the system in which the LCD module will be assembled matches specified viewing angle of this LCD module.
- (21) This LCD module does not contain nor use any ODS (1,1,1-Trichloroethane, CCL₄), CFCS, Carbon tetrachloride, Halon in all materials used, in all production processes.

[For operating LCD module]

- (1) Do not operate or store the LCD module under outside of specified environmental conditions.
- (2) At the shipment, adjust the contrast of each LCD module with electric volume. LCD contrast may vary from panel to panel depending on variation of LCD power voltage from system.
- (3) As opt-electrical characteristics of LCD will be changed, dependent on the temperature, the confirmation of display quality and characteristics has to be done after temperature is set at 25 °C and it becomes stable.

[Precautions for Storage]

- (1) Do not expose the LCD module to direct sunlight or strong ultraviolet light for long periods. Store in a dark place.
- (2) The liquid crystal material will solidify if stored below the rated storage temperature and will become an isotropic liquid if stored above the rated storage temperature, and may not retain its original properties. Only store the module at normal temperature and humidity (25±5°C, 60±10%RH) in order to avoid exposing the front polarizer to chronic humidity.

(3) Keeping Method

a. Don't keeping under the direct sunlight.

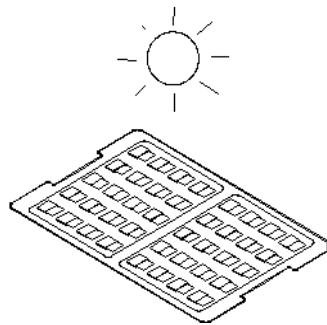
DON'T

b. Keeping in the tray under the dark place.

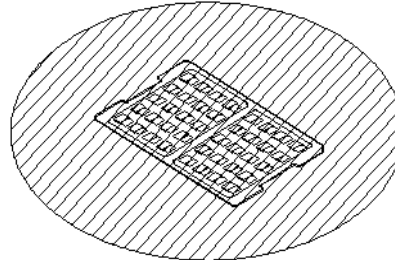
DO

(1) Do not operate or store the LCD module under outside of specified environmental conditions.

(2) Be sure to prevent light striking the chip surface.

[Other Notice]

(1) Do not operate or store the LCD module under outside of specified environmental conditions.

(2) As electrical impedance of power supply lines (VCI/VDDIO-GND) are low when LCD module is working, place the de-coupling capacitor near by LCD module as close as possible.

(3) Reset signal must be sent after power on to initialize LSI. LSI does not function properly until initialize it by reset signal.

(4) Generally, at power on, in order not to apply DC charge directly to LCD panel, supply logic voltage first and initialize LSI logic function including polarity alternation. Then supply voltage for LCD bias. At power off, in order not to apply DC charge directly to LCD panel, execute Power OFF sequence and Discharge command.

(5) Don't touch to FPC surface, exposed IC chip, electric parts and other parts, to any electric, metallic materials.

(6) Be sure to turn off the power supply and the signals when inserting or disconnecting the FPC.

(7) No bromide specific fire-retardant material is used in this module.

(8) Do not display still picture on the display over 2 hours as this will damage the liquid crystal.

(9) Afterimage may occur for several seconds when this LCD module is turned off.

(10) This product doesn't support active backlight function. Use active back light function with this product at your discretion and responsibility.

(11) Please do not put directly on the floor, and keep the wrapping box on the palette or the stand to avoid the dewy. Moreover, please arrange it in a constant direction correctly to improve ventilation under the palette. Please separate from the wall in the storage warehouse and keep it.

[Precautions for Discarding Liquid Crystal Modules]

COG: After removing the LSI from the liquid crystal panel, dispose of it in a similar way to circuit boards from electronic devices.

LCD panel: Dispose of as glass waste. This LCD module contains no harmful substances. The liquid crystal panel contains no dangerous or harmful substances. The liquid crystal panel only contains an extremely small amount of liquid crystal (approx.100mg) and therefore it will not leak even if the panel should break.

-Its median lethal dose (LD50) is greater than 2,000 mg/kg and a mutagenetic (Aims test: negative) material is employed. FPC: Dispose of as similar way to circuit board from electric device

1. Application

This data sheet is to introduce the specification of LQ043Y1DX07 active matrix 16.7Mcolors LCD module.

This LCD module is designed for a cellular telephone and this is controlled by Driver IC

(HX8363A/RAMless).

If any problem occurs concerning the items not stated in this specification, it must be solved sincerely by both parties after deliberation.

As to basic specification of driver IC refer to the IC specification and handbook.

2. Construction and Outline

This module is a color transmissive, high contrast, wide viewing angle and active matrix LCD module incorporating amorphous silicon TFT (Thin Film Transistor), named ASV LCD (Advanced Super View LCD).

Construction: LCD panel, Driver (COG) for controlling pixel addressing, FPC with electric components, 8 white LEDs prism sheet, diffuser, light guide and reflector, plastic frame and metal frame to fix them mechanically.

Outline: See page ** (Fig.1 Outline Dimensions)

Connection: Connector (Panasonic AXE660124) /

There shall be no scratches, stains, chips, distortions and other external drawbacks that may affect the display function.

Rejection criteria shall be noted in Inspection Standard.

3. Mechanical (Physical) Specifications

Table1

Item	Specifications	Unit	Remarks
Screen size	10.9 (4.30" type) Diagonal	cm	
Active area	56.16(H)×93.60(V)	mm	
Pixel format	480(H)×800(V)	pixel	
	1 Pixel =R+G+B dots	-	
Pixel pitch	0.117(H)×0.117(V)	mm	
Pixel configuration	R,G,B vertical stripes	-	
Display mode	Normally black	-	
Unit outline dimensions	62.46(W)×105.9(H)×2.1(D)	mm	【Note3-1】
Mass	30	g	
Surface hardness	3H(Initial)	-	Pencil hardness

【Note3-1】 The above-mentioned table indicates module sizes without some projections and FPC.

For detailed measurements and tolerances, please refer to Fig.1 Outline Dimensions.

4. Pixel Configuration

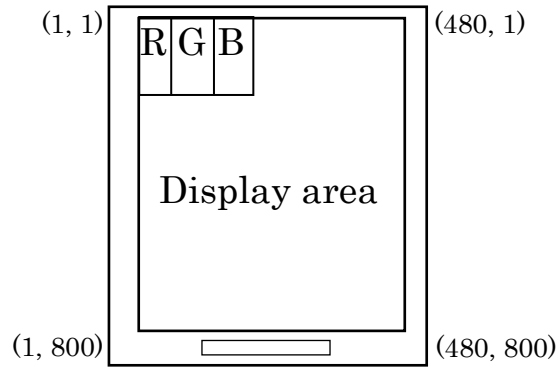

5. Input Terminal Names and Functions

CN1

Table2

Pin No.	Symbol	I/O	Description	Remarks
1	GND	-	Ground	
2	GND	-	Ground	
3	NC	-	No Connection	
4	SDO	O	SPI I/F data out from LCM	
5	SDI	I	SPI I/F data In to LCM	
6	GND	-	Ground	
7	SCL	I	SPI I/F clock	
8	CSX	I	SPI I/F chip select	
9	RESX	I	Device reset signal	
10	GND	-	Ground	
11	DR7	I	Red data signal (MSB)	
12	DR6	I	Red data signal	
13	DR5	I	Red data signal	
14	DR4	I	Red data signal	
15	GND	-	Ground	
16	DR3	I	Red data signal	
17	DR2	I	Red data signal	
18	DR1	I	Red data signal	
19	DR0	I/O	Red data signal (LSB) (10kΩ±5% Pull-Down GND)	
20	GND	-	Ground	
21	DG7	I	Green data signal (MSB)	
22	DG6	I	Green data signal	
23	DG5	I	Green data signal	
24	DG4	I	Green data signal	
25	GND	-	Ground	
26	DG3	I	Green data signal	
27	DG2	I	Green data signal	
28	DG1	I	Green data signal	
29	DG0	I	Green data signal (LSB)	
30	GND	-	Ground	
31	DB7	I	Blue data signal (MSB)	
32	DB6	I	Blue data signal	
33	DB5	I	Blue data signal	
34	DB4	-	Blue data signal	

Pin No.	Symbol	I/O	Description	Remarks
35	GND	-	Ground	
36	DB3	I	Blue data signal	
37	DB2	I	Blue data signal	
38	DB1	I	Blue data signal	
39	DB0	I	Blue data signal (LSB)	
40	DE	I	Data enable	
41	GND	-	Ground	
42	PCLK	I	Pixel clock signal	
43	GND	-	Ground	
44	HS	I	Horizontal synchronous signal	
45	VS	I	Vertical synchronous signal	
46	VDDIO	-	Power supply for I/O	
47	VCI	-	Power supply for analog	
48	NC	-	No Connection	
49	LEDK	-	Power Supply for LED(Cathode)	Connected to pin-50
50	LEDK	-	Power Supply for LED(Cathode)	Connected to pin-49
51	LEDA	-	Power Supply for LED(Anode)	
52	GND	-	Ground	
53	NC	-	No Connection	
54	GND-TP	-	No Connection	
55	S1	-	No Connection	
56	S2	-	No Connection	
57	S3	-	No Connection	
58	VDD-TP	-	No Connection	
59	S4	-	No Connection	
60	GND-TP	-	No Connection	

【Note5-1】 CN2 is not used by this module.

6. Absolute Maximum Ratings

Table 3

GND=0V

Parameter	Symbol	Conditions	Rated value	Unit	Remarks
Driver IC (Analog) Power Supply Voltage	VCI	Ta=+25°C	-0.3 ~ +4.6	V	【Note6-1】
Driver IC (Digital) Power Supply Voltage	VDDIO	Ta=+25°C	-0.3 ~ +4.6	V	【Note6-1】
Temperature for storage	T _{stg}	-	-40 ~ +80	°C	【Note6-2】
Temperature for operation	T _{opr}	-	-20 ~ +60	°C	【Note6-2】
LED Input electric current	I _{LED}	Ta=+25°C	35	mA	【Note6-3】

【Note6-1】 Voltage applied to GND pins. GND pin conditions are based on all the same voltage (0V).

Always connect all GND externally and use at the same voltage.

【Note6-2】 Humidity : 95%RHMax.(at Ta≤40°C). Maximum wet-bulb temperature is less than 39°C(at Ta>40°C). Condensation of dew must be avoided.

【Note6-3】 Ambient temperature and the maximum input are fulfilling the following operating conditions.

※Please refer to specification of “Himax HX8363A” for detail.

■ Ambient Temperature vs.
Allowable Forward Current

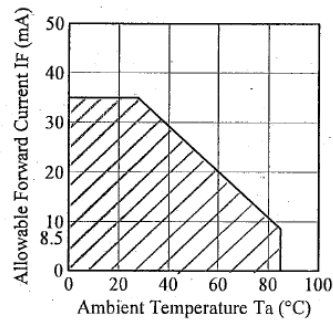

7. Electrical Characteristics

7-1. TFT-LCD Panel Driving Section

Table 4

GND=0V

Parameter	Symbol	Min.	Typ.	Max.	Unit	Remarks
Driver IC(Analog) Power Supply Voltage	V _{CI}	2.75	3.0	3.3	V	【Note7-1】
Driver IC(Digital) Power Supply Voltage	V _{DDIO}	1.65	2.6	3.3	V	【Note7-1】
Permissive input Ripple voltage	V _{RFVCI}	-	-	100	mVp-p	【Note7-2】
	V _{RFVDDIO}	-	-	100	mVp-p	【Note7-2】
Input voltage (Low)	V _{IL}	0	-	0.3V _{DDIO}	V	【Note7-3】
Input voltage (High)	V _{IH}	0.7V _{DDIO}	-	V _{DDIO}	V	【Note7-3】
Input current (Low)	I _{IL}	-1	-	-	μA	
Input current (High)	I _{IH}	-	-	1	μA	
Output voltage (Low)	V _{oL}	0	-	0.2V _{DDIO}	V	I _{oL} =+0.1mA
Output voltage (High)	V _{oH}	0.8V _{DDIO}	-	V _{DDIO}	V	I _{oH} =-0.1mA
Power consumption	P _{norm}	-	88	140	mW	【Note7-4】
		-	76	-	mW	【Note7-5】
		-	37	-	mW	【Note7-6】
		-	57	-	mW	【Note7-7】

【Note7-1】 Include Ripple Noise

【Note7-2】 V_{CI} = 3.0V, V_{DDIO} = 2.6V

【Note7-3】 Applied overshoot

【Note7-4】 Measurement Conditions : Checker pattern (Worst case), PCLK=25MHz

【Note7-5】 Measurement Conditions : White pattern, PCLK=25MHz

【Note7-6】 Measurement Conditions : Black pattern, PCLK=25MHz

【Note7-7】 Measurement Conditions : Color ber pattern (following pattern), PCLK=25MHz



※Please refer to specification of “Himax HX8363A” for detail.

7-2. Back Light Driving Section

Table 5

Ta=+25°C, GND=0V

Parameter	Symbol	Min.	Typ.	Max.	Unit	Remarks
LED Voltage	V_{LED}	-	+25.6	-	V	【Note7-8】
LED Current	I_{LED}	-	20	-	mA	
Power Consumption	W_{LED}	-	512	-	mW	【Note7-9】
LED Quantity		8			pcs	
LED Rank		Brightness:W700~W825			-	NSSW206A
		Chromaticity:Sbj2, Sbk2			-	

【Note7-8】 at $I_{LED}=20mA$

【Note7-9】 $W_{LED}=V_L \times I_L$

【Note7-10】 LED-FPC schematic

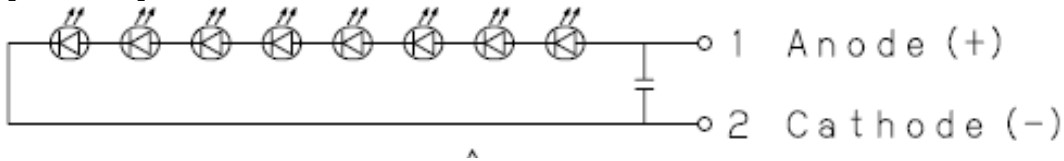

Capacitor: 0.47uF / B / 30V maximum

7-3. Resistance of Rear metal bezel

Initial resistance of Rear metal bezel is 1 Ω or less.

Please refer to Note 7-10 below for measuring method.

【Note7-10】 Measuring method

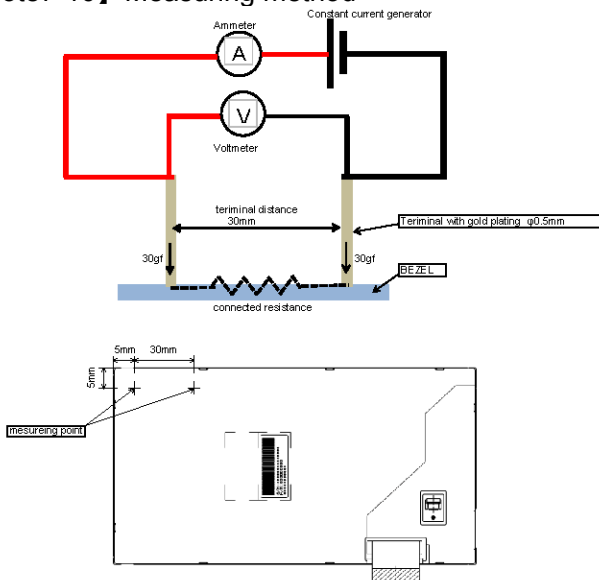

Ammeter : Digital multimeter Agilent 34411A
 Voltmeter : Digital multimeter Agilent 34411A
 Constant current generator : Regulated DC Power Supply KENWOOD PW18-1.3ATS

8. Timing characteristics of input signals

Please refer to specification of “Himax HX8363A” for detail.

8-1.Reset Timing Characteristics

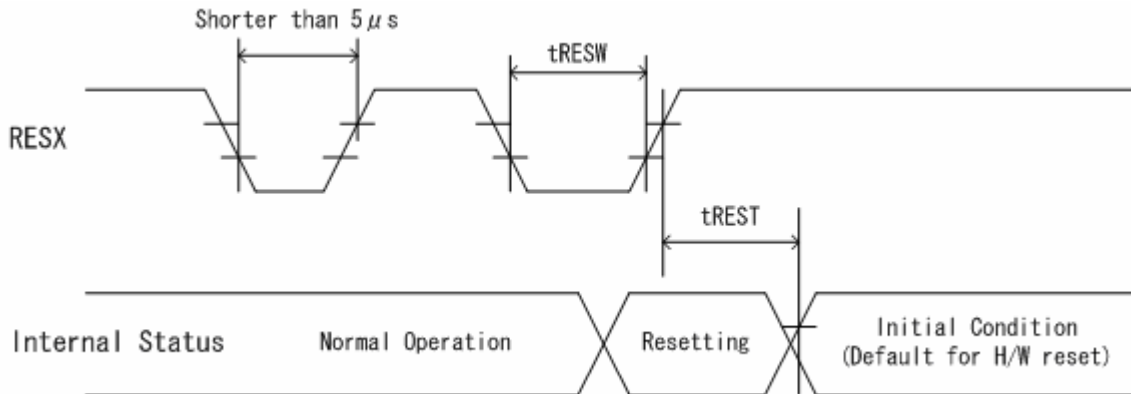

Table 6 $T_a=+25^{\circ}\text{C}$, $\text{GND}=0\text{V}$, $\text{VCI}=2.75\text{V}$ to 3.3V , $\text{VDDIO}=1.65\text{V}$ to 3.3V

Parameter	Symbol	MIN.	TYP.	MAX.	Unit	Remarks
Reset “Low” pulse width	tRESW	10	-	-	μs	
Reset complete time	tREST	-	-	5	ms	【Note8-1】
		-	-	120	ms	【Note8-2】

【Note8-1】 When reset is applied during sleep in mode

【Note8-2】 When reset is applied during sleep out mode

8-2. Serial Interface Timing Characteristics

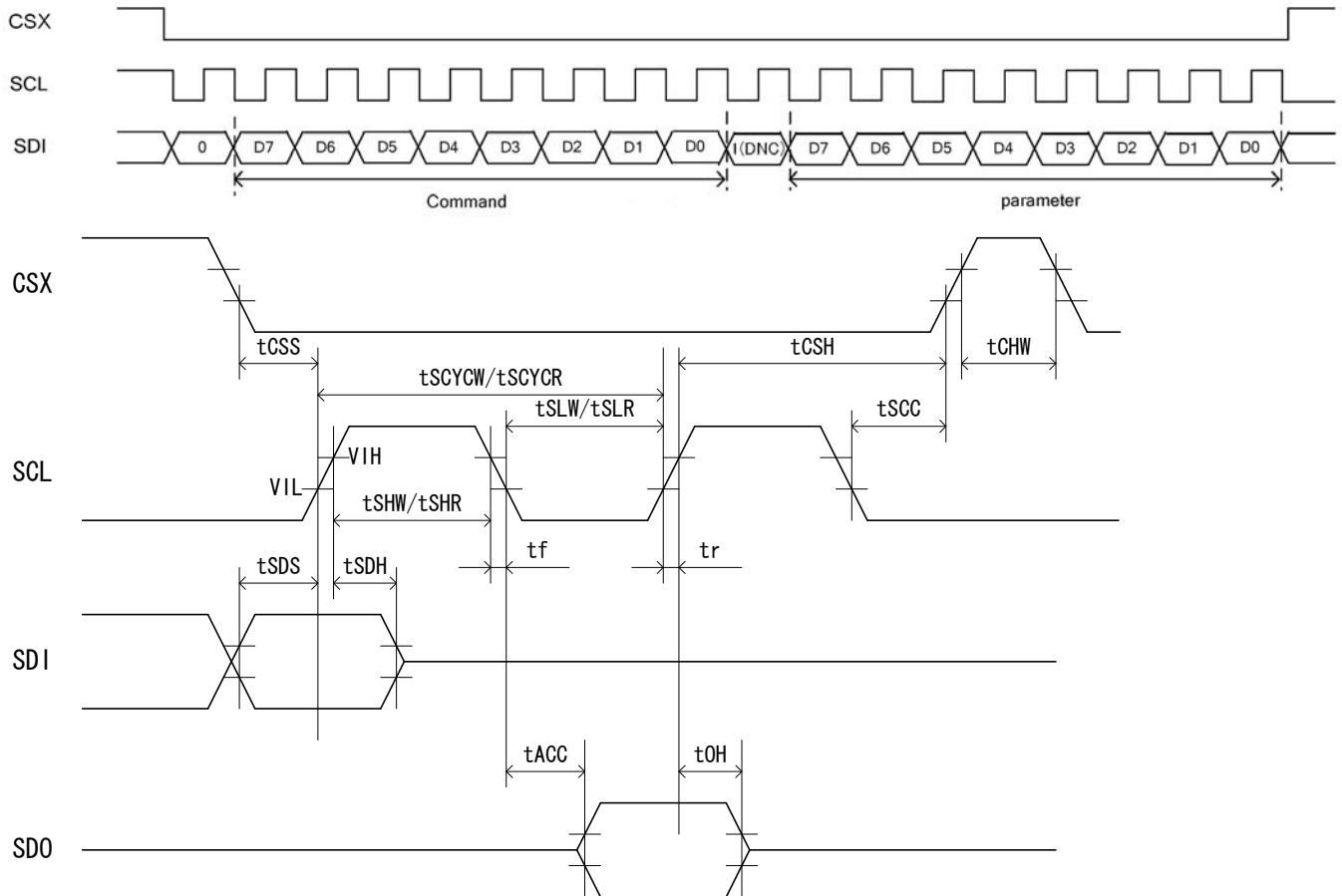
Table 7 $T_a=+25^{\circ}\text{C}$, $\text{GND}=0\text{V}$, $\text{VCI}=2.75\text{V to }3.3\text{V}$, $\text{VDDIO}=1.65\text{V to }3.3\text{V}$

Parameter	Symbol	MIN.	TYP.	MAX.	Unit	Remarks
Serial clock cycle(Write)	t_{SCYCW}	80	-	-	ns	
SCL "H" pulse width(Write)	t_{SHW}	30	-	-	ns	
SCL "L" pulse width(Write)	t_{SLW}	30	-	-	ns	
Data setup time(Write)	t_{SDS}	10	-	-	ns	
Data hold time(Write)	t_{SDH}	10	-	-	ns	
Serial clock cycle(Read)	t_{SCYCR}	150	-	-	ns	
SCL "H" pulse width(Read)	t_{SHR}	60	-	-	ns	
SCL "L" pulse width(Read)	t_{SLR}	60	-	-	ns	
Access time	t_{ACC}	10	-	60	ns	【Note8-3】
Output disable time	t_{OH}	15	-	100	ns	【Note8-3】
SCL to Chip select	t_{SCC}	30	-	-	ns	
CSX "H" pulse width	t_{CHW}	60	-	-	ns	
CSX-SCL time(Write)	t_{CSS}	30	-	-	ns	
	t_{CSH}	30	-	-	ns	
CSX-SCL time(Read)	t_{CSS}	60	-	-	ns	
	t_{CSH}	65	-	-	ns	

【Note8-3】 SDO for maximum. $\text{CL}=30\text{pF}$. For maximum $\text{CL}=8\text{pF}$.

8-3. Vertical Timing Characteristics

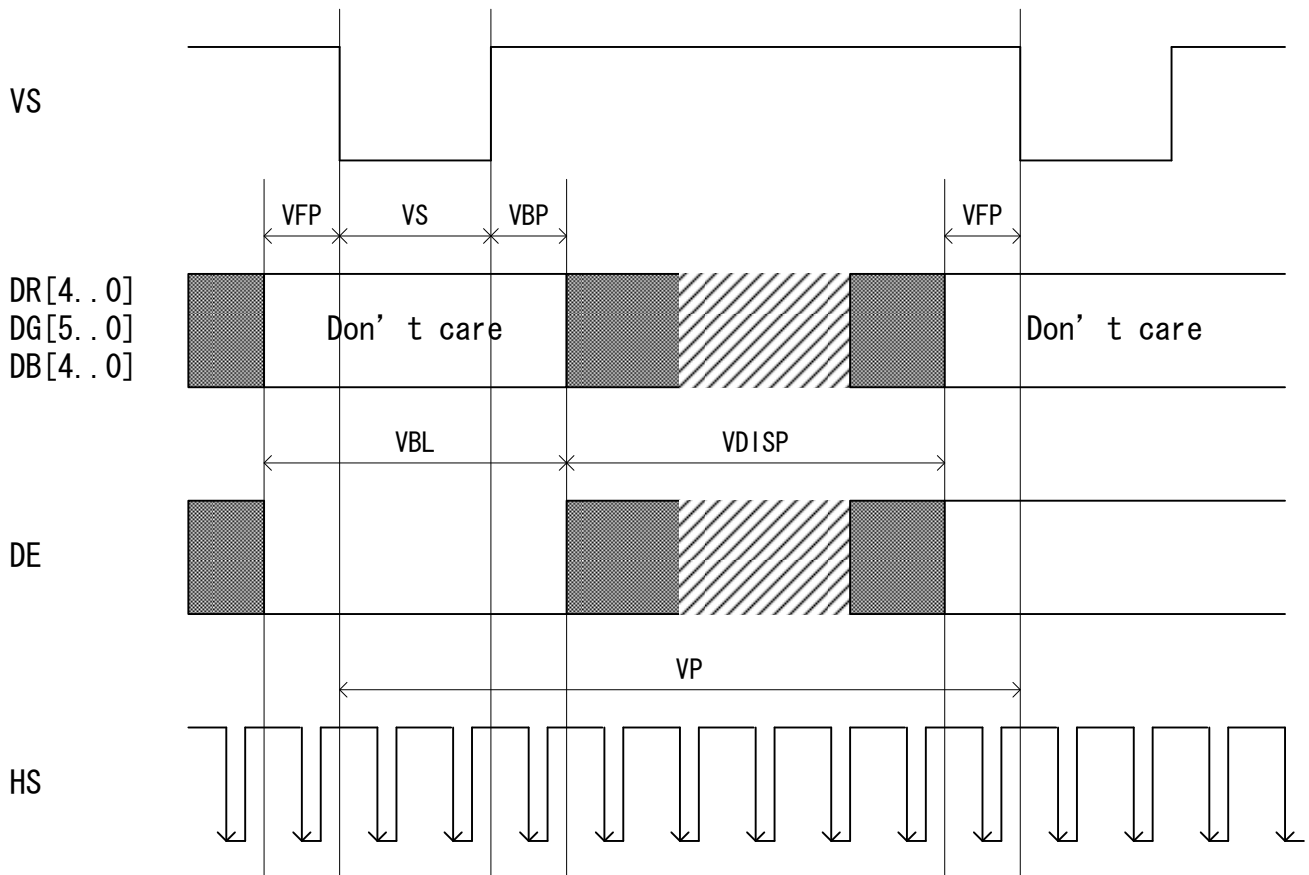
Table 8 $T_a=+25^{\circ}\text{C}$, $\text{GND}=0\text{V}$, $\text{VCI}=2.75\text{V to }3.3\text{V}$, $\text{VDDIO}=1.65\text{V to }3.3\text{V}$

Parameter	Symbol	MIN.	TYP.	MAX.	Unit	Remarks
Vertical cycle	VP	806	809	810	Line	
Vertical low pulse width	VS	2	3	4	Line	
Vertical front porch	VFP	2	3	4	Line	
Vertical back porch	VBP	2	3	4	Line	
Vertical data start point	-	4	6	8	Line	【Note8-4】
Vertical blanking period	VBL	6	9	10	Line	【Note8-5】
Vertical active area	-	-	800	-	Line	【Note8-6】
Vertical refresh rate	VRR	55	60	65	Hz	

【Note8-4】 $\text{VS}+\text{VBP}$ 【Note8-5】 $\text{VS}+\text{VBP}+\text{VFP}$ 【Note8-6】 VDISP

8-4. Horizontal Timing Characteristics

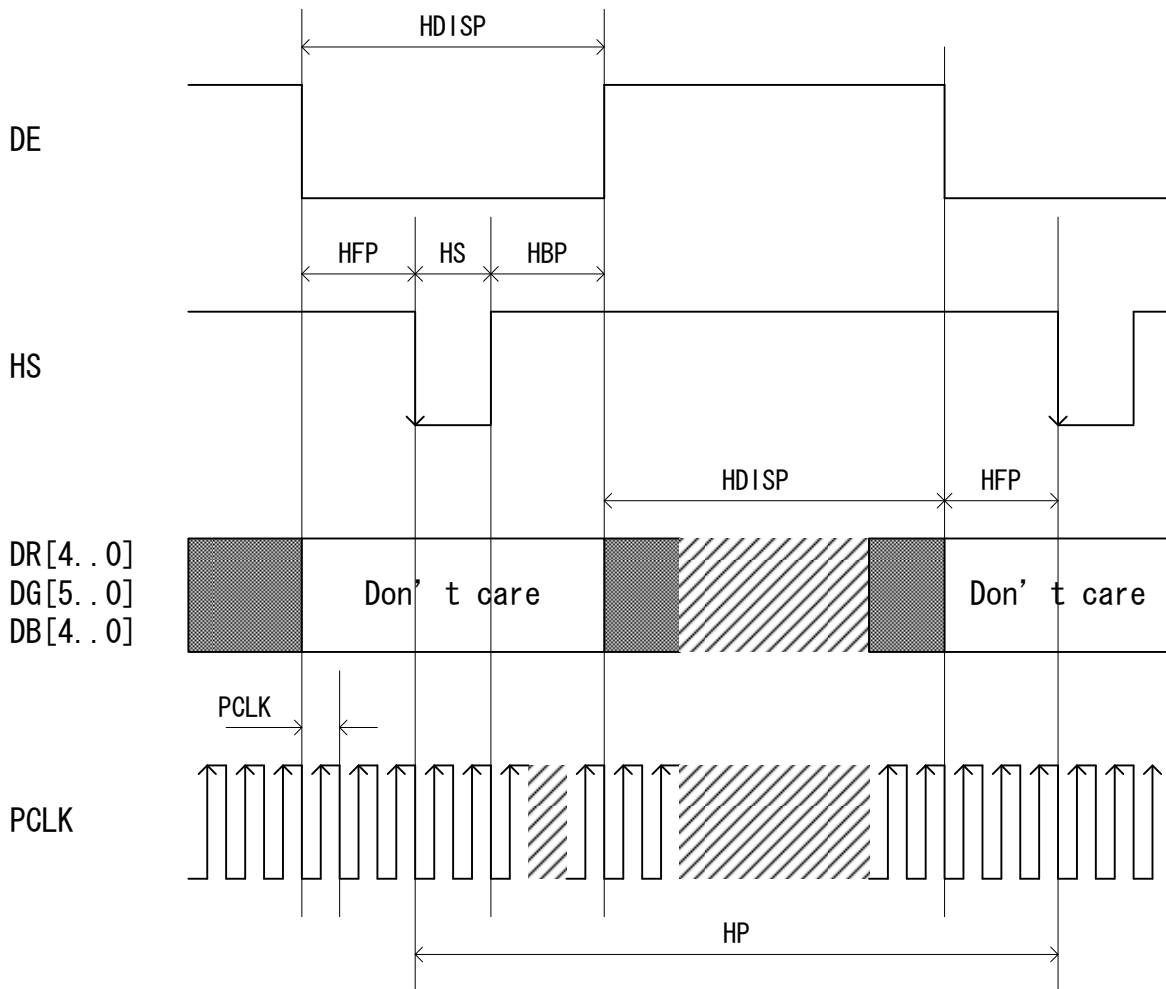

Table 9 Ta=+25°C, GND=0V, VCI=2.75V to 3.3V, VDDIO=1.65V to 3.3V

Parameter	Symbol	MIN.	TYP.	MAX.	Unit	Remarks
HS cycle	HP	504	507	568	DCK	
HS low pulse width	HS	5	6	256	DCK	
Horizontal back porch	HBP	5	15	256	DCK	
Horizontal front porch	HFP	5	6	256	DCK	
Horizontal data start point	-	19	21	83	DCK	【Note8-7】
Horizontal blanking period	HBLK	24	27	88	DCK	【Note8-8】
Horizontal active area	HDISP	-	480	-	DCK	
Pixel clock frequency When RGB I/F is running	DCK	20.3	24.58	32.2	MHz	【Note8-9】
		31	40.68	49.2	ns	

【Note8-7】 HS+HBP

【Note8-8】 HS+HBP+HFP

【Note8-9】 VRR=Min.55Hz. – Max.65Hz

8-5. General Timing Characteristics

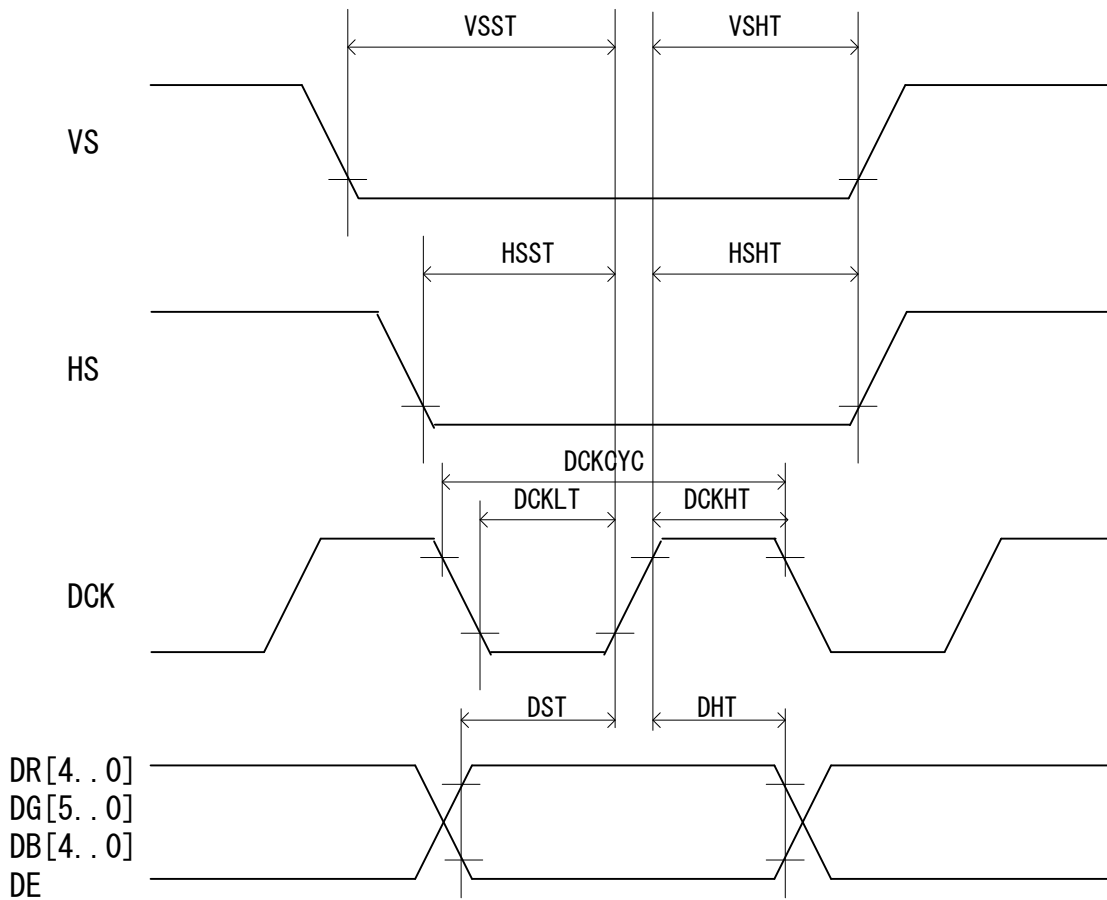
Table 10 $T_a=+25^{\circ}\text{C}$, GND=0V, VCI=2.75V to 3.3V, VDDIO=1.65V to 3.3V

Parameter	Symbol	MIN.	TYP.	MAX.	Unit	Remarks
Vertical sync setup time	VSST	5	-	-	ns	
Vertical sync hold time	VSHT	5	-	-	ns	
Horizontal sync setup time	HSST	5	-	-	ns	
Horizontal sync hold time	HSHT	5	-	-	ns	
Pixel clock cycle When RGB I/F is running	DCKCYC	31 【Note8-10】	-	49.2 【Note8-11】	ns	【Note8-12】
Pixel clock low time	DCKLT	5	-	-	ns	
Pixel clock high time	DCKHT	5	-	-	ns	
Data setup time	DST	5	-	-	ns	
Data hold time	DHT	5	-	-	ns	

【Note8-10】 32.2MHz

【Note8-11】 20.3MHz

【Note8-12】 VRR=Min.55Hz. – Max.65Hz

9. Power Sequence

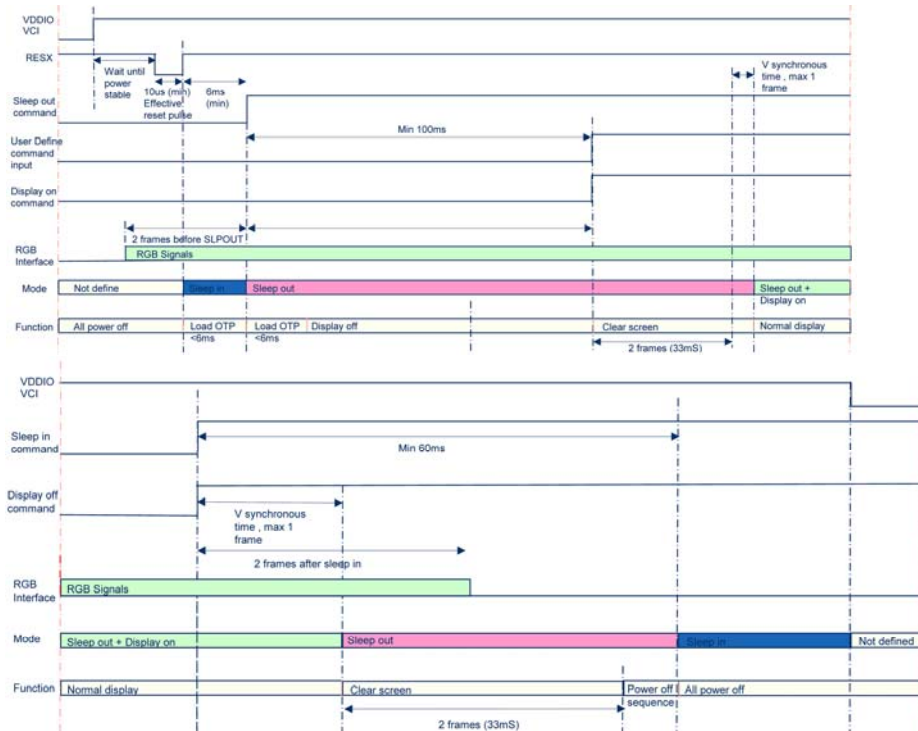

9-1 Power On Sequence

Table 11

ITEM	Register Address	Register Data list	REMARK
VDDIO(2.6V),VCI(3.0V) ON (anytime VDDIO≤VCI),RESX=H			
WAIT until power stable			
RESX=L			
Wait min.10us(Effective reset pulse)			
RESX=H(Reset release)			
WAIT min. 6ms , RGB signals should be send for 2 frames before SLPOUT command.			
SLEEP OUT	11	**	SLPOUT
WAIT min. 100ms			
RGB Interface Format Setting	B9	FF	User Define Command RGB=888 Setting
		83	
		63	
	3A	70	
Read ID2	DB	81	
Display On	29	**	DISPON
WAIT 2frames(33ms) + max1frame			
Normal display			

9-2 Power Off Sequence

Table 12

ITEM	Register Address	Register Data list	REMARK
Normal display			
Display Off	28	**	DISPOFF
Sleep In	10	**	SLEEPIN
WAIT min. 60ms			
(RGB signals should be send for 2 frames after SLPIN command.)			
VDDIO(2.6V),VCI(3.0V) OFF (anytime VDDIO≤VCI)			

10. Input Signals, Basic Display Colors and Gray Scale of Each Color

Table 13

	Colors & Gray Scale	Data signals																																
		Gray Scale	R0	R1	R2	R3	R4	R5	R6	R7	G0	G1	G2	G3	G4	G5	G6	G7	B0	B1	B2	B3	B4	B5	B6	B7								
		LSB							MSB							LSB							MSB											
Basic Color	Black	—	0	0	0	0	0	0	0	0	0	0	0	0	0	0	0	0	0	0	0	0	0	0	0	0	0	0	0	0	0	0	0	0
	Blue	—	0	0	0	0	0	0	0	0	0	0	0	0	0	0	0	0	1	1	1	1	1	1	1	1	1	1	1	1	1	1	1	1
	Green	—	0	0	0	0	0	0	0	0	1	1	1	1	1	1	1	1	0	0	0	0	0	0	0	0	0	0	0	0	0	0	0	0
	Cyan	—	0	0	0	0	0	0	0	0	1	1	1	1	1	1	1	1	1	1	1	1	1	1	1	1	1	1	1	1	1	1	1	1
	Red	—	1	1	1	1	1	1	1	1	0	0	0	0	0	0	0	0	0	0	0	0	0	0	0	0	0	0	0	0	0	0	0	0
	Magenta	—	1	1	1	1	1	1	1	1	0	0	0	0	0	0	0	0	1	1	1	1	1	1	1	1	1	1	1	1	1	1	1	1
	Yellow	—	1	1	1	1	1	1	1	1	1	1	1	1	1	1	1	1	0	0	0	0	0	0	0	0	0	0	0	0	0	0	0	0
	White	—	1	1	1	1	1	1	1	1	1	1	1	1	1	1	1	1	1	1	1	1	1	1	1	1	1	1	1	1	1	1	1	1
Gray Scale of Red	Black	GS0	0	0	0	0	0	0	0	0	0	0	0	0	0	0	0	0	0	0	0	0	0	0	0	0	0	0	0	0	0	0	0	0
	↑	GS1	1	0	0	0	0	0	0	0	0	0	0	0	0	0	0	0	0	0	0	0	0	0	0	0	0	0	0	0	0	0	0	0
	Darker	GS2	0	1	0	0	0	0	0	0	0	0	0	0	0	0	0	0	0	0	0	0	0	0	0	0	0	0	0	0	0	0	0	0
	↑	↓	↓							↓							↓																	
	↓	↓	↓							↓							↓																	
	Brighter	GS253	1	0	1	1	1	1	1	1	0	0	0	0	0	0	0	0	0	0	0	0	0	0	0	0	0	0	0	0	0	0	0	0
	↓	GS254	0	1	1	1	1	1	1	1	0	0	0	0	0	0	0	0	0	0	0	0	0	0	0	0	0	0	0	0	0	0	0	0
	Red	GS255	1	1	1	1	1	1	1	1	0	0	0	0	0	0	0	0	0	0	0	0	0	0	0	0	0	0	0	0	0	0	0	0
Gray Scale of Green	Black	GS0	0	0	0	0	0	0	0	0	0	0	0	0	0	0	0	0	0	0	0	0	0	0	0	0	0	0	0	0	0	0	0	0
	↑	GS1	0	0	0	0	0	0	0	0	1	0	0	0	0	0	0	0	0	0	0	0	0	0	0	0	0	0	0	0	0	0	0	0
	Darker	GS2	0	0	0	0	0	0	0	0	0	1	0	0	0	0	0	0	0	0	0	0	0	0	0	0	0	0	0	0	0	0	0	0
	↑	↓	↓							↓							↓																	
	↓	↓	↓							↓							↓																	
	Brighter	GS253	0	0	0	0	0	0	0	0	1	0	1	1	1	1	1	1	0	0	0	0	0	0	0	0	0	0	0	0	0	0	0	0
	↓	GS254	0	0	0	0	0	0	0	0	0	1	1	1	1	1	1	1	0	0	0	0	0	0	0	0	0	0	0	0	0	0	0	0
	Green	GS255	0	0	0	0	0	0	0	0	1	1	1	1	1	1	1	1	0	0	0	0	0	0	0	0	0	0	0	0	0	0	0	0
Gray Scale of Blue	Black	GS0	0	0	0	0	0	0	0	0	0	0	0	0	0	0	0	0	0	0	0	0	0	0	0	0	0	0	0	0	0	0	0	0
	↑	GS1	0	0	0	0	0	0	0	0	0	0	0	0	0	0	0	0	1	0	0	0	0	0	0	0	0	0	0	0	0	0	0	0
	Darker	GS2	0	0	0	0	0	0	0	0	0	0	0	0	0	0	0	0	0	1	0	0	0	0	0	0	0	0	0	0	0	0	0	0
	↑	↓	↓							↓							↓																	
	↓	↓	↓							↓							↓																	
	Brighter	GS253	0	0	0	0	0	0	0	0	0	0	0	0	0	0	0	0	1	0	1	1	1	1	1	1	1	1	1	1	1	1	1	1
	↓	GS254	0	0	0	0	0	0	0	0	0	0	0	0	0	0	0	0	0	1	1	1	1	1	1	1	1	1	1	1	1	1	1	1
	Blue	GS255	0	0	0	0	0	0	0	0	0	0	0	0	0	0	0	0	1	1	1	1	1	1	1	1	1	1	1	1	1	1	1	1

Low level voltage, 1: High level voltage

Each basic color can be displayed in 256 gray scales from 8 bit data signals. According to the combination of total 24 bit data signals, the 16,777,216-color display can be achieved on the screen.

11. Optical Characteristics

11-1 Driving the Back Light Condition

Table 14

Ta=+25°C

Parameter	Symbol	Condition	Min.	Typ.	Max.	Unit	Remark
Viewing Angle Range	θ3, θ9	CR>10	70	80	-	degree	【Note11-1, 11-2】
	θ6, θ12		70	80	-	degree	
Contrast Ratio	CR	θ=0°	720	870	-	-	【Note11-2】
Response Time	Tr +Td	θ=0°	-	-	35	ms	【Note11-3】
White Chromaticity	x	θ=0°	0.280	0.310	0.340	-	
	y		0.290	0.320	0.350	-	
Red Chromaticity	x		0.616	0.651	0.686	-	
	y		0.310	0.345	0.380	-	
Green Chromaticity	x		0.227	0.262	0.297	-	
	y		0.631	0.666	0.701	-	
Blue Chromaticity	x		0.107	0.142	0.177	-	
	y		0.003	0.036	0.071	-	
Brightness	XL1	θ=0°	250	315	-	cd/m ²	I _{LED} =20mA
Uniformity	U	θ=0°	75	85	-	%	【Note11-6】
NTSC Ratio	S		80	90	-	%	
Gamma	γ	θ=0°	1.8	2.2	2.6	-	
Flicker	F	θ=0°	-	-	-20	dB	【Note11-7】

*The measuring method of the optical characteristics is shown by the following figure.

*A measurement device is TOPCON luminance meter SR-3.(Viewing cone1.)

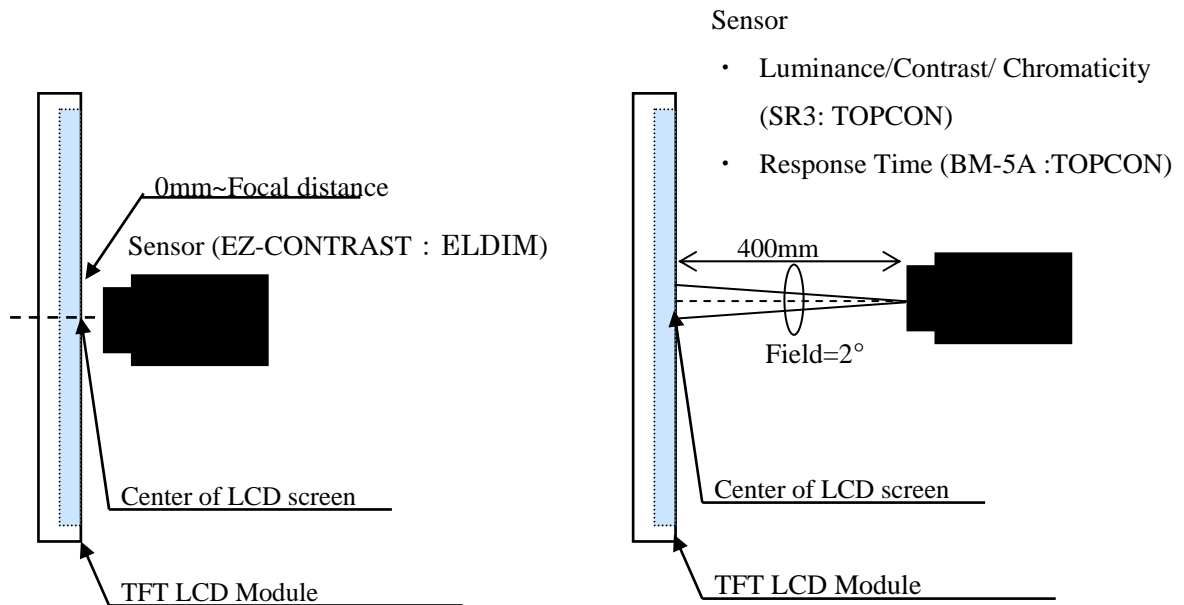

Measuring Method for Optical Characteristics

【Note 11-1】 Viewing angle range is defined as follows.

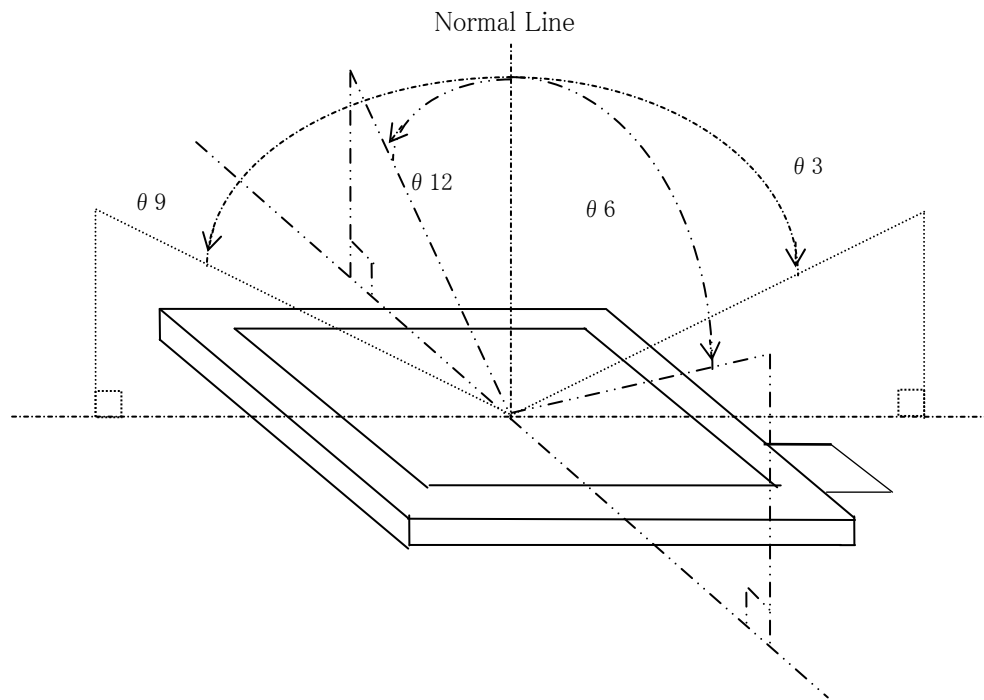

【Note 11-2】 Definition of contrast ratio:

The contrast ratio is defined as the follows:

$$\text{Contrast ratio (CR)} = \frac{\text{Luminance (brightness) with all pixels white}}{\text{Luminance (brightness) with all pixels black}}$$

【Note 11-3】 Definition of response time:

The response time is defined as the following figure and shall be measured by switching the input signal for “black” and “white”

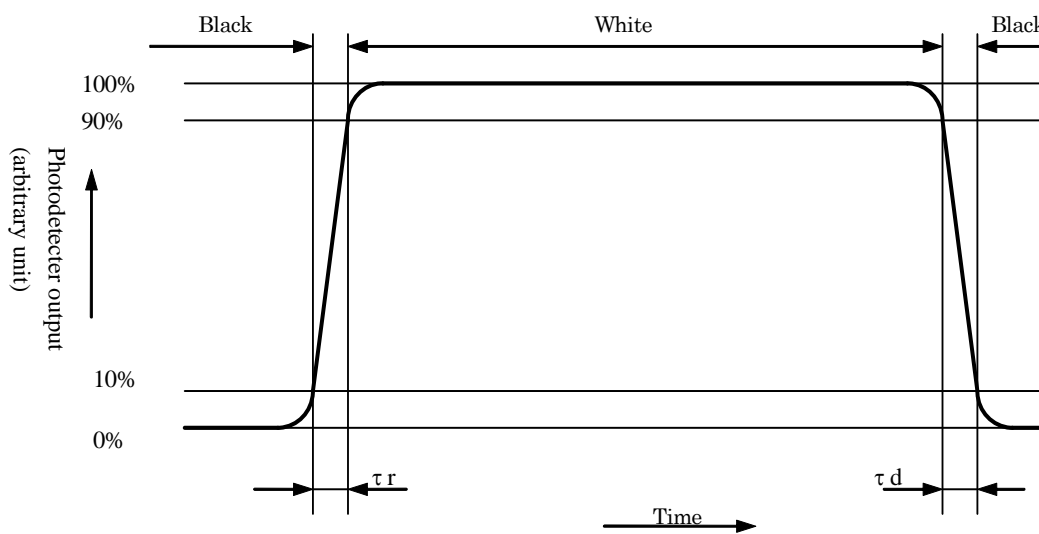

【Note 11-6】 Definition of Uniformity.

$$\text{Uniformity} = \frac{\text{Minimum Brightness}}{\text{Maximum Brightness}} \times 100 (\%)$$

The brightness should be measured on the 9-points as shown in the following figure.

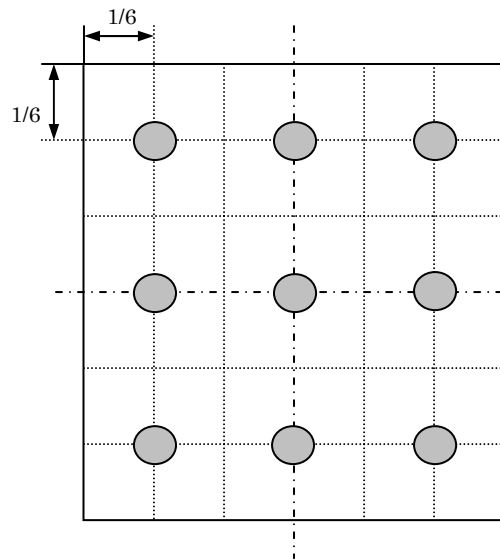

【Note 11-7】 A measurement point is panel center.

Conversion of Flicker ratio : Flicker[dB] = $20\log(\text{ACrms}/\text{DC})$

Frame rate range : 53Hz ~ 63Hz

12. Reliability Test Items

Table 15

No.	Test item	Conditions
1	High temperature storage test	Ta = +80°C, 240h
2	Low temperature storage test	Ta = -40°C, 240h
3	High temperature and high humidity storage test	Ta = +40°C95%RH, 240h (No condensation)
4	High temperature operation test	Ta = +60°C, 240h
5	Low temperature operation test	Ta = -20°C, 240h
6	High temperature and high humidity operation test	Ta = +40°C95%RH, 240h (No condensation)
7	Heat shock test	Ta = -40°C(30min)~80°C(30min), 50cycle
8	Image remaining test	Black/White block interleave pattern. (Room Temperature, 48 Hours)
		Black/White block interleave pattern. (40°C, 12 Hours)
9	Shock test	Half Sin, 400 G, 2 ms, 6 faces(±X, ±Y & ±Z), Non-Op
10	Vibration test(storage test)	Sine: 10-500-10Hz, 6 G, 30min (1 cycle: 10~500~10 Hz, 15 min/cycle, 2 cycles), X, Y, Z
		Random: 10-500Hz (6 Grms (0.074 G ² /Hz)), 500-2000Hz (-3db/octave), 60min, X, Y, Z
11	Vibration test(operation test)	Sine: 10-500-10Hz, 6 G, 30min (1 cycle: 10~500~10 Hz, 15 min/cycle, 2 cycles), X, Y, Z
		Random: 10-500Hz (6 Grms (0.074 G ² /Hz)), 500-2000Hz (-3db/octave), 60min, X, Y, Z
12	Anti-Dust test	The box fills with enough talcum powder to cover up UUT and the box only contain 1 unit. Test shall be continued for a period of 1 minute.
		IEC60529 IP5X Temperature Range:15°C to 35°C Relative Humidity:25% TO 75% Air Pressure:86kPa to 106kPa Particle size:50 micrometer Duration time:8 hours
13	FPC Bending Test	Bending 30 times by bending radius R2.0mm and angle=360°(LCD FPC)
14	FPC Insert/Remove test	Insert/Remove LCD FPC for 15 cycles.
15	Low Pressure storage test	40,000 ft, 188 hpa, Room Temperature, 48 Hours.
16	Low Pressure operation test	15,000 ft, 572 hpa, Room Temperature, 48 Hours.
17	LED Life test	Luminance should be larger than half of initial luminance after 5,000 hours operating. (ILED=20 mA, Ta=25°C)
18	Electro static discharge test	±200V, 200pF(0Ω) to Terminals(Contact) (1 time for each terminals) ±8kV, 150pF(330Ω) to Housing bezel(Contact) ±15kV, 150pF(330Ω) to Housing bezel(Air) IEC 61000-4-2

*Ta = Ambient temperature

*Check items

In the standard condition, there shall be no practical problems that may affect the display function.

13. Indication of lot number

The lot number is shown on a label. Attached location is shown in Fig.1 (Outline Dimensions).

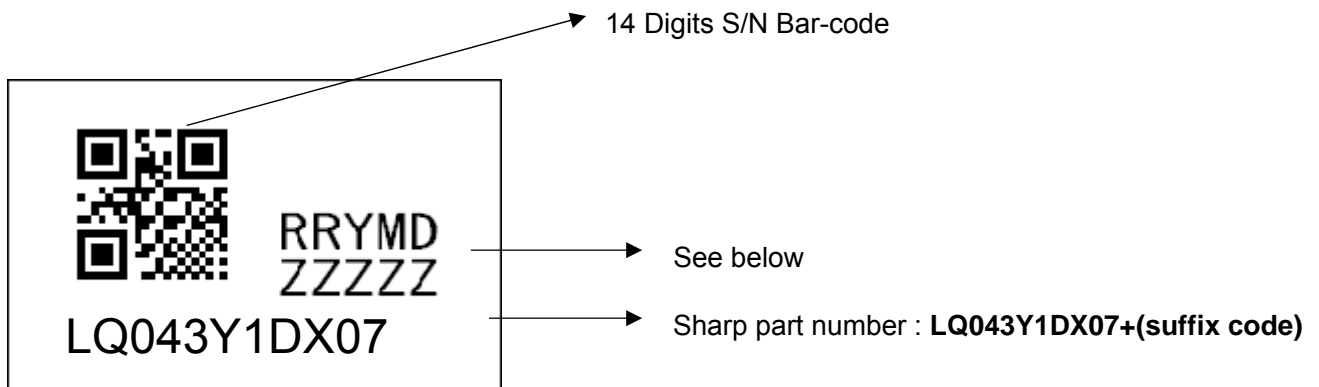

S/N:RRYMDZZZZZ

RR : Revision code

Y : Manufacture year

M :Manufacture month

D :Manufacture day

Z :Remaining 5 digits of serial number

14. Forwarding form

- (a) Piling number of cartons : 8 deep
- (b) Package quality in one cartons : 200 pcs
- (c) Carton size : 530 mm × 365 mm × 235 mm
- (d) Total mass of 1 carton filled with full modules : approximately 8.1kg

Condition for storage

Environment

- (1) Temperature : 0~40°C
- (2) Humidity : 60%RH or less(at 40°C)
- (3) Atmosphere : Harmful gas, such as acid or alkali which erodes electronic components and/or wires, must not be detected.
- (4) Period : about 3 months
- (5) Opening of the package : In order to prevent the LCD module from breakdown by electrostatic charges, please control the room humidity over 50%RH and open the package taking sufficient countermeasures against electrostatic charges, such as earth, etc.

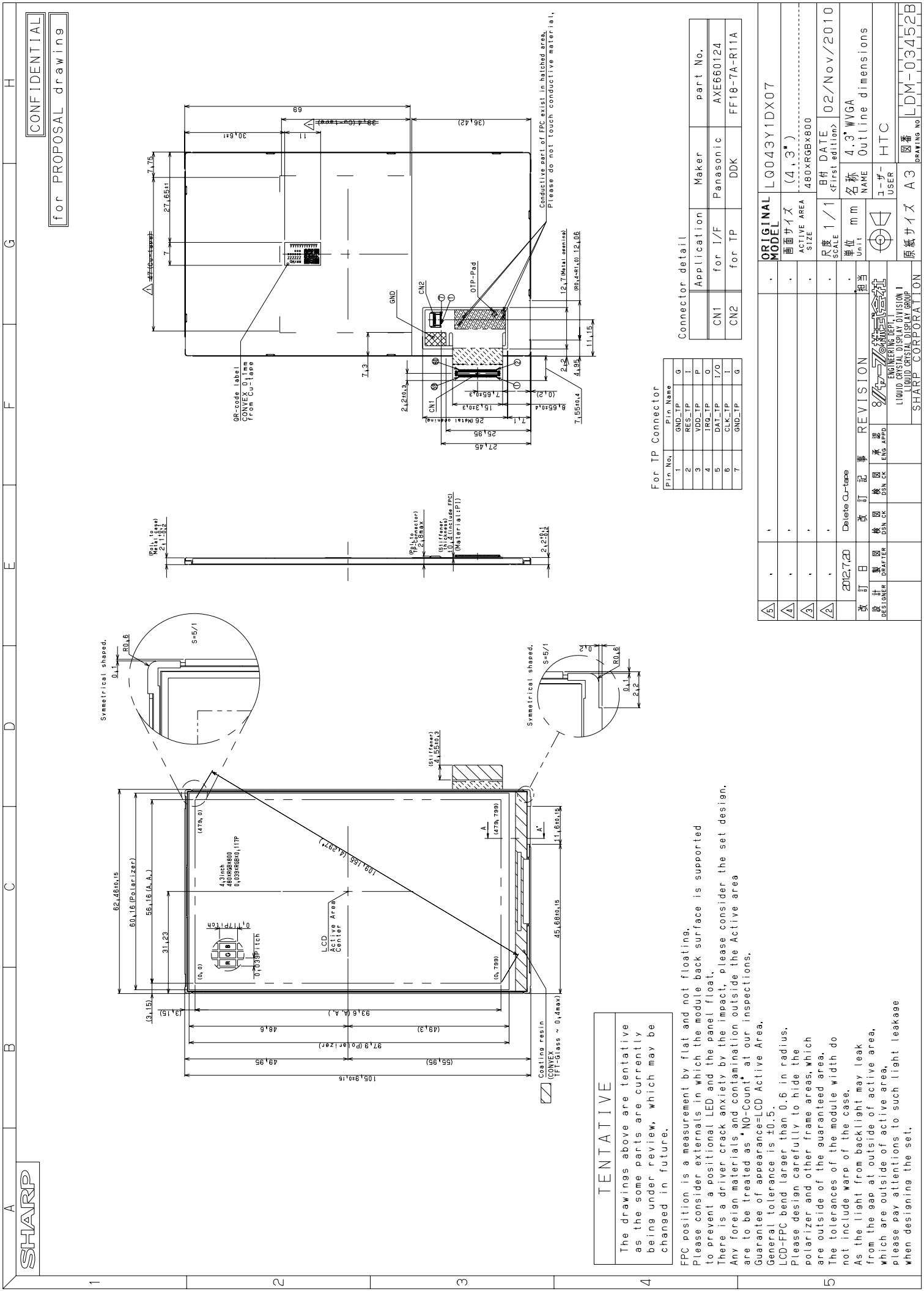

CONFIDENTIAL
for PROPOSAL drawing

TENTATIVE
The drawings above are tentative as the some parts are currently being under review, which may be changed in future.

FPC position is a measurement by flat and not floating. Please consider externals in which the module back surface is supported to prevent a positional LED and the panel float. There is a driver crack anxiety by the impact, please consider the set design. Any foreign materials and contamination outside the Active area are to be treated as 'NO-Count' at our inspections. Guarantee of appearance=LCD Active Area. General tolerance is ±0.5. LCD-FPC bend larger than 0.6 in radius. Please design carefully to hide the polarizer and other frame areas, which are outside of the guaranteed area. The tolerances of the module width do not include warp of the case. As the light from backlight may leak from the gap at outside of active area, please pay attentions to such light leakage when designing the set.

For TP Connector

Pin No.	Pin Name	G
1	GND_TP	T
2	RES_TP	P
3	VDD_TP	O
4	IRO_TP	I/O
5	DAT_TP	T
6	CLK_TP	G
7	GND_TP	G

Connector detail

Application	Maker	part No.
CN1	Panasonic	AXE60124
CN2	DDK	FF18-7A-R11A

△5	・	・	ORIGINAL MODEL	LQ043Y1DX07
△4	・	・	画面上サイズ (4.3*)	ACTIVE AREA SIZE 480×RGB×800
△3	・	・	尺度 1/1 SCALE	02/Nov/2010
△2	・	・	単位 mm UNIT	名称 4.3" WVGA
改訂日	2012.7.20	Delete Cu-tape	訂者 担当	ユーザー USER
設計 製図 検図 承認	設計者 検図者 承認者	REVISION	訂者	ユーザー USER
DESIGNER DRAFTER DSN CK ENG APPD	DESIGNER DRAFTER DSN CK ENG APPD	REVISION	訂者	ユーザー USER
SHARP CORPORATION		SHARP CORPORATION		原紙サイズ A3 図番 LDM-03452B

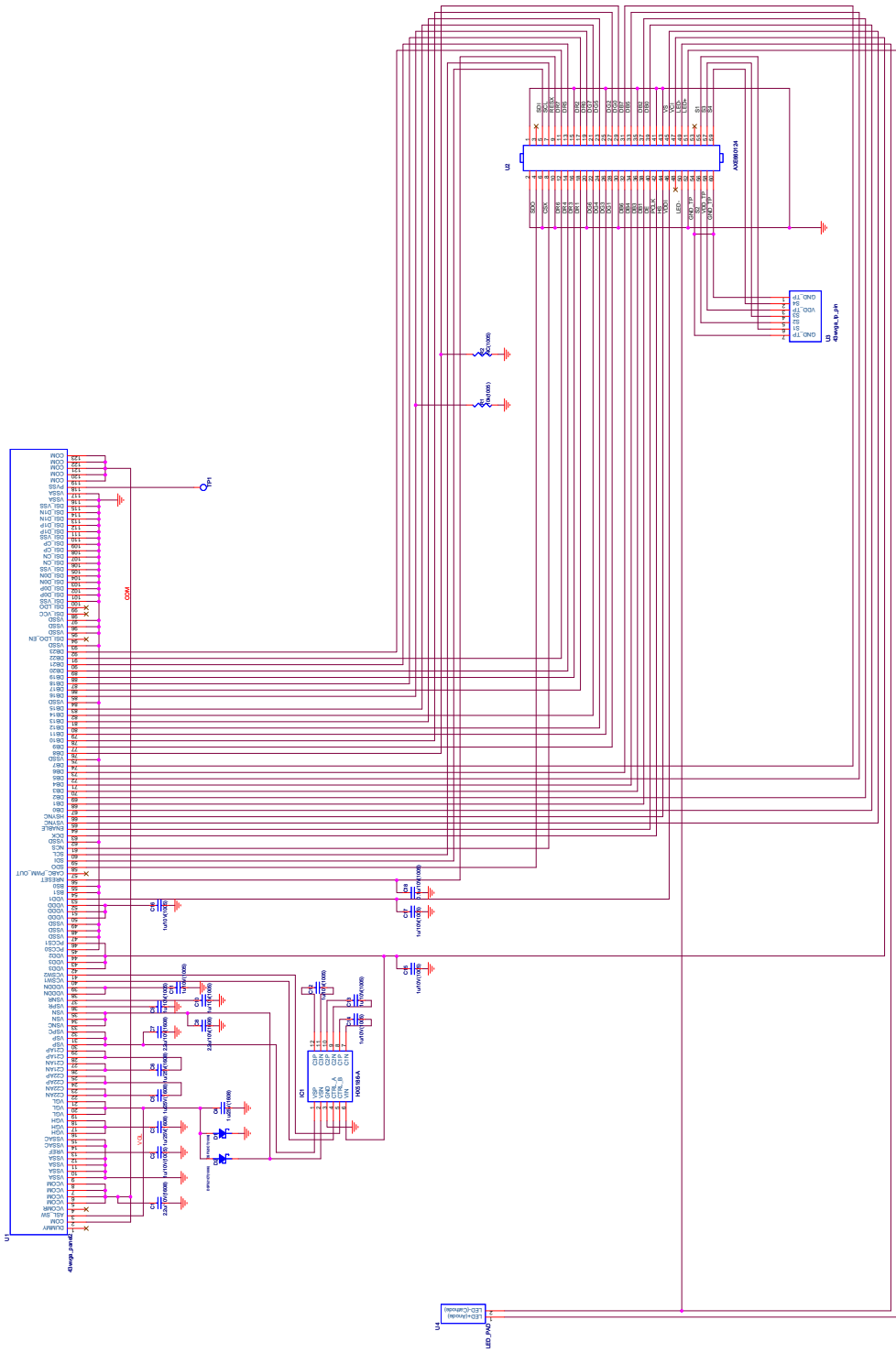

このデザイン等の部品と部品の機能の関係は
 図説(組立図)に示すこと。
 DRはパネル端子からコネクタ端子まで
 DRでケーブルリンクすること。
 DRはパネル端子からコネクタ端子まで
 DRでケーブルリンクすること。
 TP用端子はコネクタ端子からコネクタ端子まで
 DRでケーブルリンクすること。
 また、ケーブルリンクは必ずしも必要ではない。

Code Name	LS043Y1LX02
材質	仕上げ
Date	2010/04/07(改訂)
Part Name	LOD-FPC
PWB Code No.	QPWB1088TPZZ
UNIT Code No.	
図番	LDC-10109B

版	2010.7	改訂日	2010.7	改訂内容	NISHIDA
版	2010.7	改訂日	2010.7	改訂内容	NISHIDA
版	2010.7	改訂日	2010.7	改訂内容	NISHIDA
版	2010.7	改訂日	2010.7	改訂内容	NISHIDA
版	2010.7	改訂日	2010.7	改訂内容	NISHIDA
版	2010.7	改訂日	2010.7	改訂内容	NISHIDA
版	2010.7	改訂日	2010.7	改訂内容	NISHIDA
版	2010.7	改訂日	2010.7	改訂内容	NISHIDA
版	2010.7	改訂日	2010.7	改訂内容	NISHIDA
版	2010.7	改訂日	2010.7	改訂内容	NISHIDA

SHEET 1 of 1

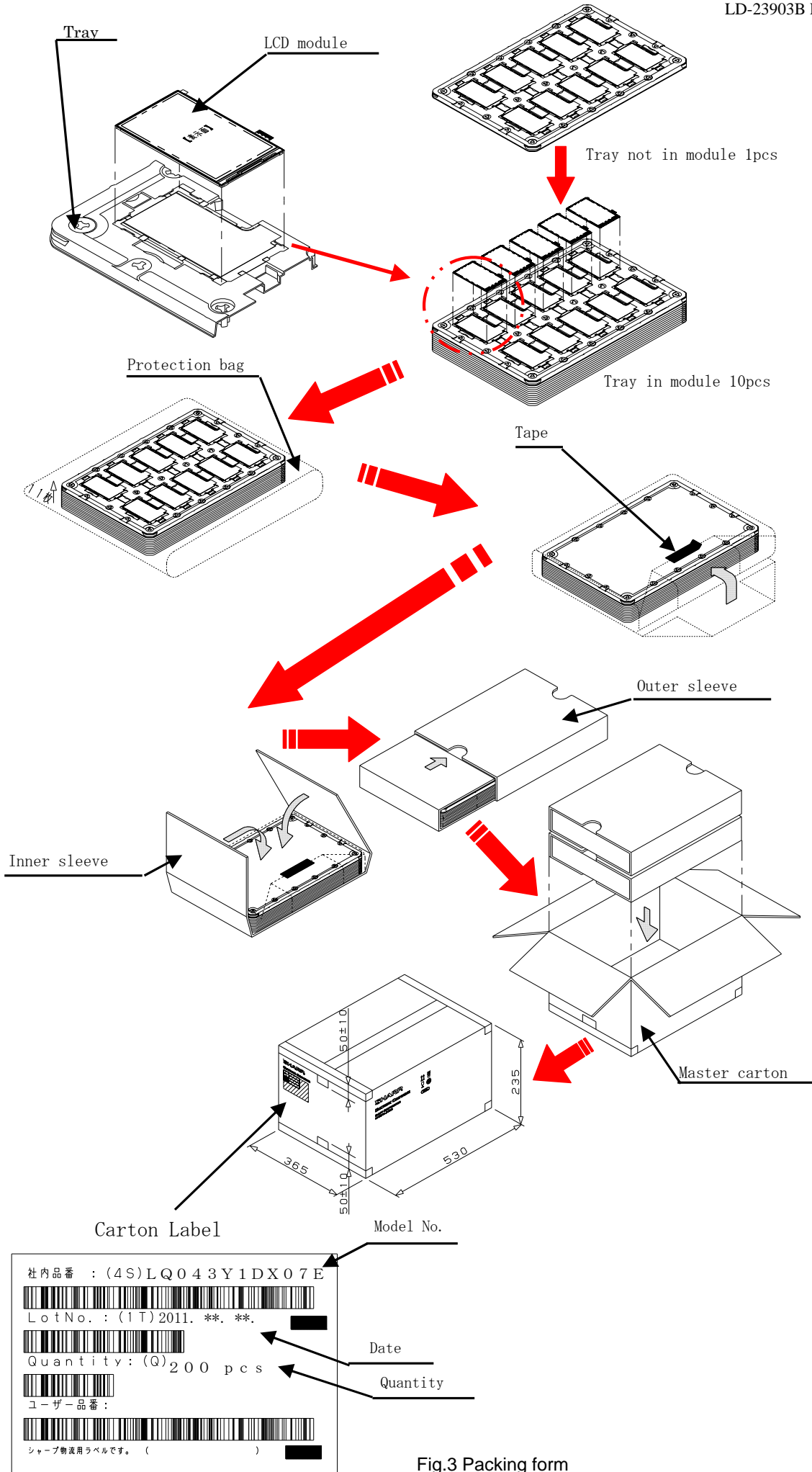

Fig.3 Packing form