

REFERENCE

SPEC. No. ED-05P079
ISSUE November 18, 2005

SHARP

OPTO-ANALOG DEVICES DIVISION
ELECTRONIC COMPONENTS GROUP
SHARP CORPORATION

SPECIFICATION

DEVICE SPECIFICATION FOR

PHOTOTRIAC COUPLER

MODEL No.

4SF21

(Business dealing name : PC4SF21 YWPSF)

Specified for

Enclosed please find copies of the Specifications which consists of 15 pages including cover.
This specification sheets and attached sheets shall be both side copy.
After confirmation of the contents, please be sure to send back copies of the Specifications
with approving signature on each.

CUSTOMER'S APPROVAL

PRESENTED

DATE

DATE

BY

BY

Id. O.

H. Imanaka,
Department General Manager of
Engineering Dept.,II
Opto-Analog Devices Div.
ELECOM Group
SHARP CORPORATION



Product name : PHOTOTRIAC COUPLER

Model No. : 4SF21

(Business dealing name : PC4SF21YWPSF)

1. These specification sheets include materials protected under copyright of Sharp Corporation ("Sharp"). Please do not reproduce or cause anyone to reproduce them without Sharp's consent.
2. When using this product, please observe the absolute maximum ratings and the instructions for use outlined in these specification sheets, as well as the precautions mentioned below. Sharp assumes no responsibility for any damage resulting from use of the product which does not comply with the absolute maximum ratings and the instructions included in these specification sheets, and the precautions mentioned below.

(Precautions)

- (1) This product is designed for use in the following application areas ;

(· OA equipment Audio visual equipment · Home appliances
· Telecommunication equipment (Terminal) · Measuring equipment
· Tooling machines · Computers)

If the use of the product in the above application areas is for equipment listed in paragraphs (2) or (3), please be sure to observe the precautions given in those respective paragraphs.

- (2) Appropriate measures, such as fail-safe design and redundant design considering the safety design of the overall system and equipment, should be taken to ensure reliability and safety when this product is used for equipment which demands high reliability and safety in function and precision, such as ;

(· Transportation control and safety equipment (aircraft, train, automobile etc.)
· Traffic signals · Gas leakage sensor breakers · Rescue and security equipment
· Other safety equipment)

- (3) Please do not use this product for equipment which require extremely high reliability and safety in function and precision, such as ;

(· Space equipment · Telecommunication equipment (for trunk lines)
· Nuclear power control equipment · Medical equipment)

- (4) Please contact and consult with a Sharp sales representative if there are any questions regarding interpretation of the above three paragraphs.

3. Please contact and consult with a Sharp sales representative for any questions about this product.



1. Application

This specification applies to the outline and characteristics of lead free type phototriac coupler Model No. 4SF21
(Apply line voltage 200V AC).

2. Outline

Refer to the attached sheet, page 6.

3. Ratings and characteristics

Refer to the attached sheet, page 7 to 8.

4. Reliability

Refer to the attached sheet, page 9.

5. Outgoing inspection

Refer to the attached sheet, page 10.

6. Supplement

6.1 The business dealing name shall be "PC4SF21YWPSF", when this product is ordered or delivered.

And the following selection shall be made as to the critical rate of rise of off-state voltage (dv/dt) in parameter 3.2.

$$dv/dt \geq 5kV/\mu s \quad [\text{Test conditions}] \quad V_D = 1/\sqrt{2} \cdot V_{DRM}, \quad T_a = 25^\circ C$$

6.2 Package specification

Refer to the attached sheet, page 11 to 14.

6.3 Isolation voltage shall be measured in the following method.

- (1) Short between pins 1 to 3 on the primary side and between pins 4 to 6 on the secondary side.
- (2) The dielectric withstanding tester with zero-cross circuit shall be used.
- (3) The wave form of applied voltage shall be a sine wave.

(It is recommended that the isolation voltage be measured in insulation oil.)

6.4 The relevant models are the models Approved by VDE according to DIN EN 60747-5-2.

Approved Model No. : 4SF21

VDE approved No. : 40008189 (According to the specification DIN EN 60747-5-2)

- Operating isolation voltage $U_{IORM(Peak)}$: 1140V
- Transient voltage : 9000V
- Pollution : 2
- Clearances distance (Between input and output): 8.0 mm (MIN.)
- Creepage distance (Between input and output): 8.0 mm (MIN.)
- Isolation thickness between input and output : 0.40 mm (MIN.)
- Tracking-proof : CTI 175
- Safety limit values
 - Current (I_{si}) : 200mA (Diode side)
 - Power (P_{si}) : 400mW (Phototransistor side)
 - Temperature (T_{si}) : 150°C

In order to keep safety electric isolation of photocoupler, please set the protective circuit to keep within safety limit values when the actual application equipment troubled.

• Indication of VDE approval "  " is printed on the minimum packing box.

Isolation specification according to EN 60747-5-2.

Parameter	Symbol	Conditions	Rating	Unit	Remark
Class of environmental test	-	-	40/100/21	-	Refer to the Diagram 1, 2 (Page 5/14)
Pollution	-	-	2	-	
Maximum operating isolation voltage	$U_{IORM(PEAK)}$	-	1140	V	
Partial discharge test voltage (Between input and output)	Diagram 1	$t_p=10\text{ s}, q_c < 5\text{ pC}$	1710	V	
	Diagram 2	$t_p=1\text{ s}, q_c < 5\text{ pC}$	2140	V	
Maximum over-voltage	$U_{IOTM(PEAK)}$	$t_{NI}=60\text{ s}$	9000	V	
Safety maximum ratings					Refer to Fig.1, 2 (Page 5/14)
1) Case temperature	T_{si}	$I_F=0, P_c=0$	150	°C	
2) Input current	I_{si}	$P_c=0$	200	mA	
3) Electric power (Output or Total power dissipation)	P_{si}	-	400	mW	
Isolation resistance (Test voltage between input and output ; DC 500V)	R_{ISO}	$T_a=T_{si}$	MIN. 10^9	Ω	
		$T_a=T_{opr} (MAX.)$	MIN. 10^{11}		
		$T_a=25^\circ\text{C}$	MIN. 10^{12}		

Precautions in performing isolation test

- (1) Partial discharge test methods shall be the ones according to the specifications of EN 60747-5-2
- (2) Please don't carry out isolation test (V_{iso}) over U_{IOTM} . This product deteriorates isolation characteristics by partial discharge due to applying high voltage (ex. U_{IOTM}). And there is possibility that partial discharge occurs in operating isolation voltage. (U_{IORM}).

6.5 This Model is approved by UL, CSA.

Approved Model No. : 4SF21

UL file No. : E64380

CSA file No. : CA95323

CSA approved mark “  ” shall be indicated on minimum unit package.

6.6 This product is approved by BSI, SEMKO, DEMKO and FIMKO

Approved Model No. : 4SF21

BSI Certificate No. : 6690/7421 (BS EN60065/BS EN60950)

SEMKO Certificate No. : 501744

DEMKO Certificate No. : 313322

FIMKO Certificate No. : 21600

6.7 This product is not designed against irradiation.

This product incorporates non-coherent light emitting diode.

This product is assembled with electrical input and output.

6.8 ODS materials

- ① This product shall not contain the following materials.
- ② The following materials shall not be used in the production process for this product.
Materials for ODS: CFC_s, Halon, Carbon tetrachloride, 1.1.1-Trichloroethane (Methylchloroform)

6.9 Specific brominated flame retardants such as the PBBO_s and PBB_s are not used in this device at all.

7. Notes

7.1 Circuit design

- (1) The LED used in the Phototriac coupler generally decreases the light emission power by operation.
In case of long operation time, please decide I_F value so that I_F is more than 2 times of the Maximum value of the Minimum triggering current at circuit design with considering the decreases of the light emission power of the LED. (50% / 5years)
- (2) Input current (I_F) at off state shall be set 0.1mA or less.
- (3) In case that L (Inductance) load such as motor etc. is used, please use this device after confirming whether this device operates normally in actual condition since there is a case that the zero-cross circuit works and the load does not turn on due to the phase difference of load current.
- (4) If the voltage exceeding the repetitive peak off-state voltage (V_{DRM}) in the absolute maximum ratings is applied to the phototriac, it may cause not only faulty operation but breakdown. Make sure that the surge voltage exceeding V_{DRM} shall not be applied by using the varistor, CR.

7.2 Usage

Only for triggering medium power triac and high power triac.
(This model shall be used under the conditions on which power triac turns on.)

7.3 Cleaning

- (1) Solvent cleaning : Solvent temperature 45°C or less, Immersion for 3 min or less
- (2) Ultrasonic cleaning : The effect to device by ultrasonic cleaning differs by cleaning bath size, ultrasonic power output, cleaning time, PCB size or device mounting condition etc.
Please test it in actual using condition and confirm that any defect doesn't occur before starting the ultrasonic cleaning.
- (3) Applicable solvent : Ethyl alcohol, Methyl alcohol, Isopropyl alcohol
When the other solvent is used, there are cases that the packaging resin is eroded.
Please use the other solvent after thorough confirmation is performed in actual using condition.

7.4 Precautions for Soldering Phototriac couplers

- (1) In the case of flow soldering (Whole dipping is possible.)
It is recommended that flow soldering be carried out at 270°C or less and within 10s
(Pre-heating : 100 to 150°C, 30 to 80s):Within 2 time
- (2) If solder reflow :
It is recommended to be done at the temperature and the time within the temperature profile as shown in the figure below. (2 times or less)

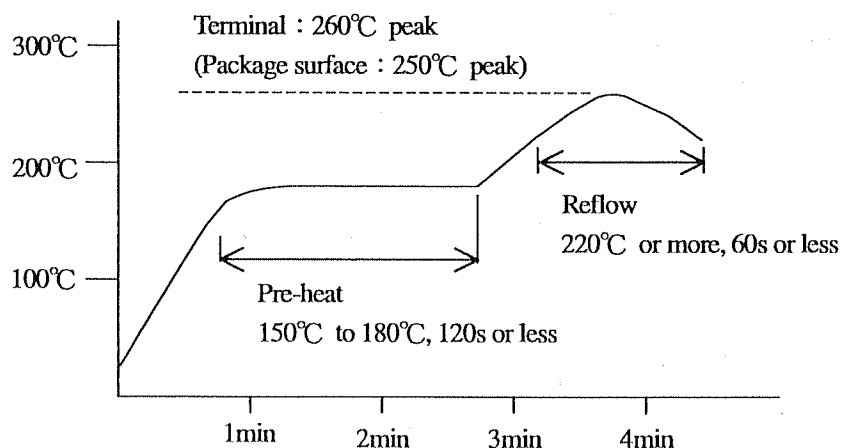

- (3) In the case of hand soldering
It is recommended that hand soldering be carried out at 400°C or less and within 3s :within 2 times
- (4) Other notes
Depending on equipment and soldering conditions (temperature, Using solder etc.), the effect to junction between PCB and lead pins of photocoupler is different.
Please confirm that there is no problem on the actual use conditions.

Method of Diagram 1: Breakdown test (Apply to type test and sampling test)

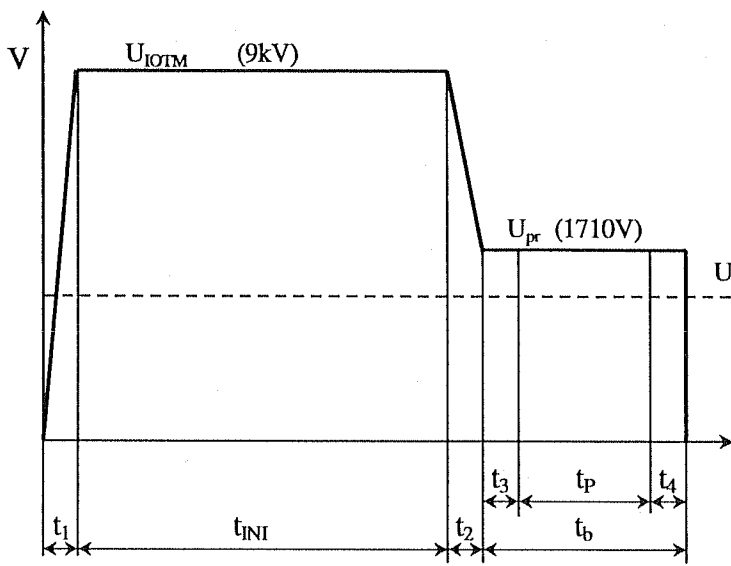

- t_1, t_2 = 1 to 10 s
- t_3, t_4 = 1 s
- t_p (Partial discharge measuring time) = 10 s
- t_b = 12 s
- t_{INI} = 60 s

Method of Diagram 2 : Non breakdown test (Apply to all device test)

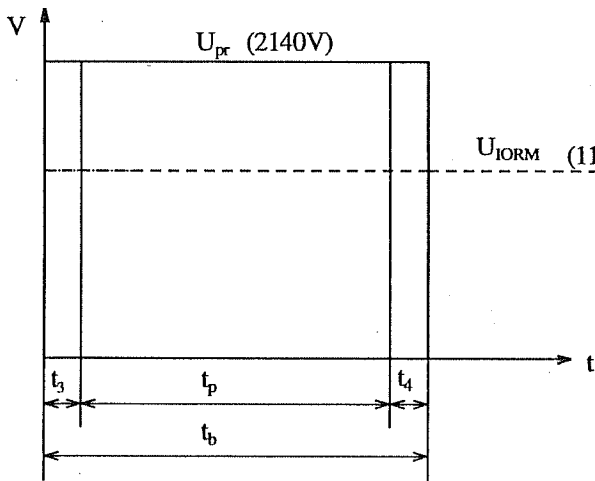

- t_3, t_4 = 0.1 s
- t_p (Partial discharge measuring time) = 1 s
- t_b = 1.2 s

Fig. 1 Safety maximum power dissipation vs. ambient temperature (When failed)

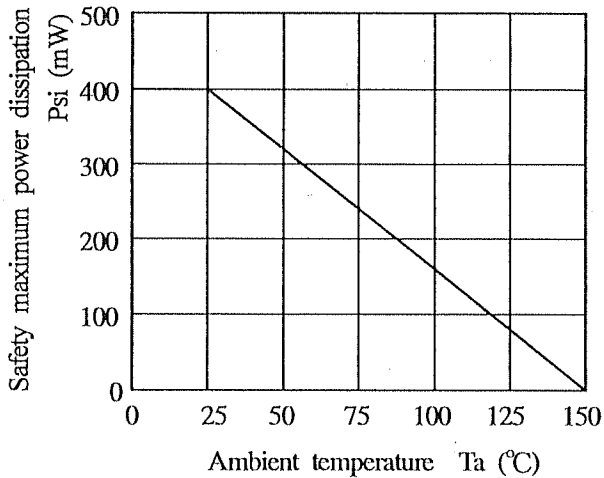
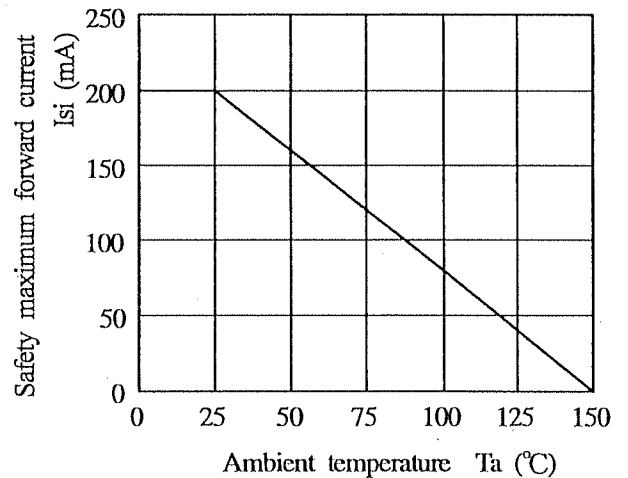
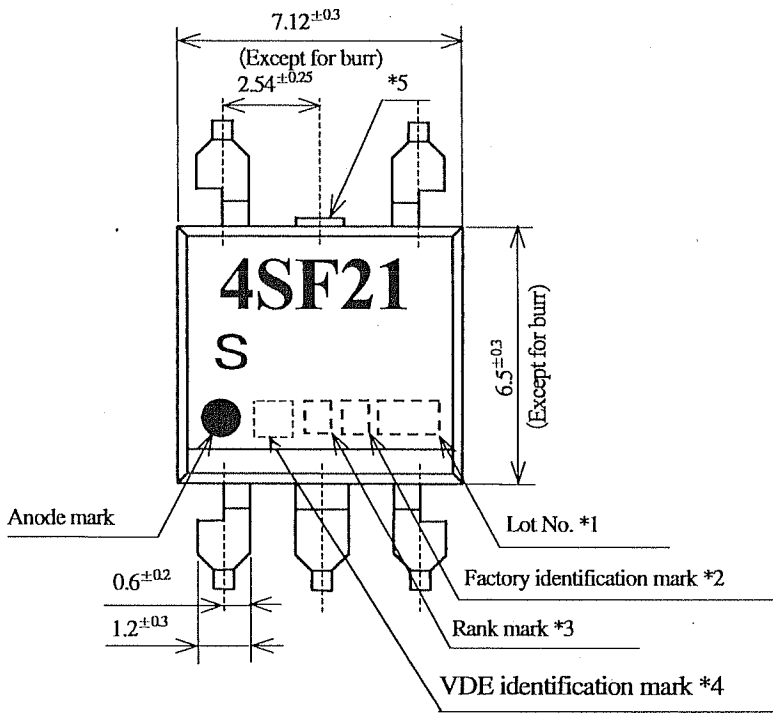

Fig. 2 Safety maximum forward current vs. ambient temperature (When failed)



REFERENCE



Pin Nos. and internal connection diagram

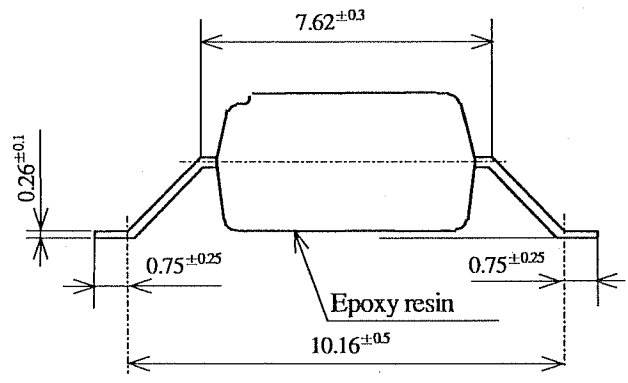
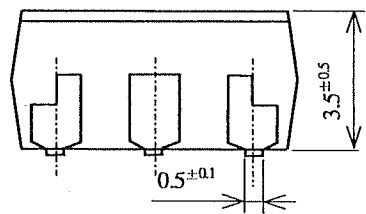
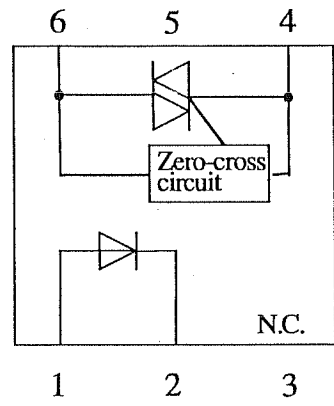

- *1) 2-digit number shall be marked according to OLD DIN standard.
- *2) Factory identification mark applies to the below.
 Without : SUN-S Corporation(Japan)
 : SUN-S Electronic Technology (KUNSHAN) Co. Ltd (China)
- *3) Rank mark : "S"
- *4) VDE identification mark shall be marked "4".
- *5) Any external connection with Pin 5 is not allowable.
 Pin 5 is cut at outside of package.
- *6) Pin material : Copper Alloy
 Pin finish : SnCu plating (Cu : TYP. 2%)

Product mass : 約0.34g

UNIT : 1 / 1 mm	
Name	4SF21 Outline Dimensions (Business dealing name:PC4SF21YWPSF)

3.1 Absolute maximum ratings

Ta=25°C

Parameter		Symbol	Rating	Unit
Input	Forward current *1	I _F	50	mA
	Reverse voltage	V _R	6	V
Output	RMS on-state current *1	I _{T(rms)}	0.1	A
	Peak one cycle surge current	I _{surge}	1.2 (50Hz sine wave)	A
	Repetitive peak off-state voltage	V _{DRM}	800	V
Isolation voltage *2		V _{iso(rms)}	5	kV
Operating temperature		T _{opr}	-30 to +100	°C
Storage temperature		T _{stg}	-55 to +125	°C
Soldering temperature		T _{sol}	270 (For 10s)	°C

*1 The derating factors of absolute maximum rating due to ambient temperature are shown in Fig.1, 2.

*2 AC for 1min, 40 to 60%RH, f=60Hz

3.2 Electrical characteristics

Ta=25°C

Parameter		Symbol	MIN.	TYP.	MAX.	Unit	Conditions
Input	Forward voltage	V _F	-	1.2	1.4	V	I _F =20mA
	Reverse current	I _R	-	-	10 ⁻⁵	A	V _R =3V
Output	Repetitive peak off-state current	I _{DRM}	-	-	3 × 10 ⁻⁶	A	V _D =V _{DRM}
	On-state voltage	V _T	-	-	2.5	V	I _T =0.05A
	Holding current	I _H	0.1	-	3.5	mA	V _D =4V
	Critical rate of rise of off-state voltage	dv/dt	500	1000	-	V/μs	V _D =1/√2 · V _{DRM}
	Zero-cross voltage	V _{OX}	-	-	20	V	I _F =15mA, R load
Transfer characteristics	Minimum trigger current	I _{FT}	-	-	7	mA	V _D =4V, R _L =100Ω
	Isolation resistance	R _{ISO}	5 × 10 ¹⁰	10 ¹¹	-	Ω	DC500V 40 to 60%RH
	Turn on time	t _{ON}	-	-	50	μs	V _D =4V, R _L =100Ω, I _F =20mA

Fig.1 Forward current vs. ambient temperature

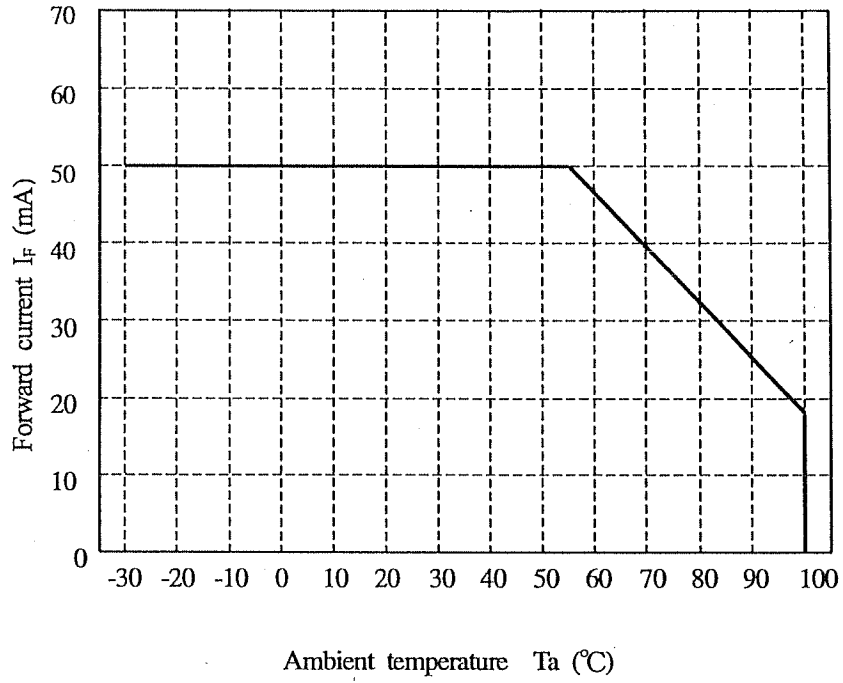
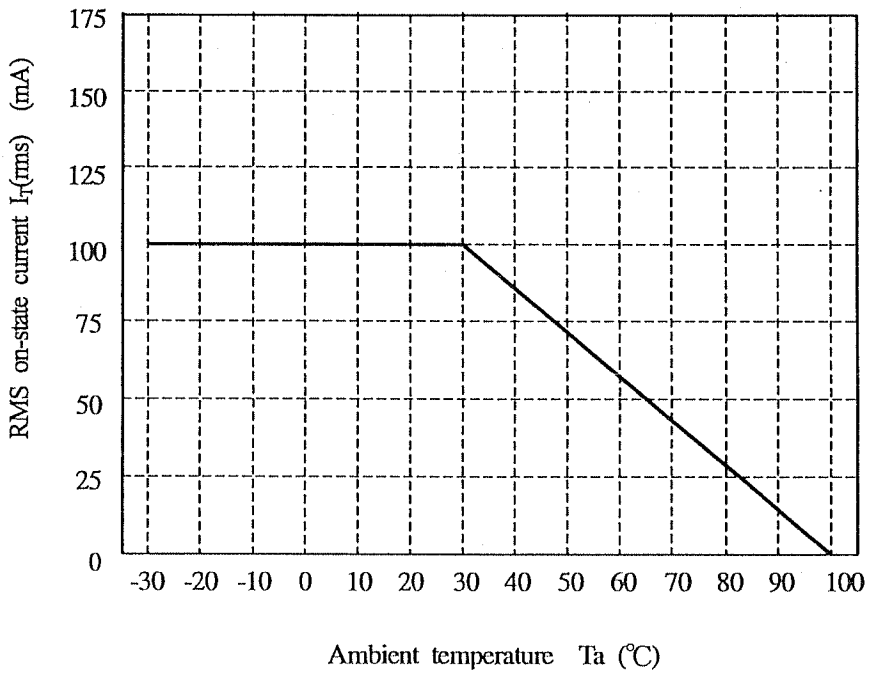
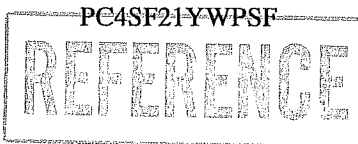

Fig.2 RMS on-state current $I_f(\text{rms})$ vs. ambient temperature





4. Reliability

The reliability of products shall satisfy items listed below.

Confidence level : 90%

LTPD : 10 or 20

Test Items	Test Conditions *1	Failure Judgement Criteria	Samples (n)
			Defective(C)
Solderability *2	245±3°C, 5s	—	n=11, C=0
Soldering heat	(Flow soldering) 270°C, 10 s	$V_F > U \times 1.2$ $V_T > U \times 1.2$ $I_{FT} > U \times 1.3$ $I_R > U \times 2.0$ $I_{DRM} > U \times 2.0$ U : Upper specification limit L : Lower specification limit	n=11, C=0
	(Soldering by hand) 400°C, 3 s		n=11, C=0
Terminal strength (Tension)	Weight : 5.0N 5 s/each terminal		n=11, C=0
Terminal strength (Bending) *3	Weight : 2.5N 2 times/each terminal		n=11, C=0
Mechanical shock	15km/s ² , 0.5ms 3 times/±X, ±Y, ±Z direction		n=11, C=0
Variable frequency vibration	100 to 2000 to 100Hz/4min 200m/s ² 4 times/ X, Y, Z direction		n=11, C=0
Temperature cycling	1 cycle -55°C to +125°C (30min) (30min) 20 cycles test Without Load		n=22, C=0
High temp. and high humidity storage	+85°C, 85%RH, 500h		n=22, C=0
High temp. storage	+125°C, 1000h		n=22, C=0
Low temp. storage	-55°C, 1000h		n=22, C=0
Operation life	I _F =50mA, I _T =100mA T _a =25°C, 1000h	n=22, C=0	

*1 Test method, conforms to EIAJ ED 4701.

*2 Solder shall adhere at the area of 95% or more of immersed portion of lead, and pin hole or other holes shall not be concentrated on one portion.

*3 Terminal bending direction is shown below.

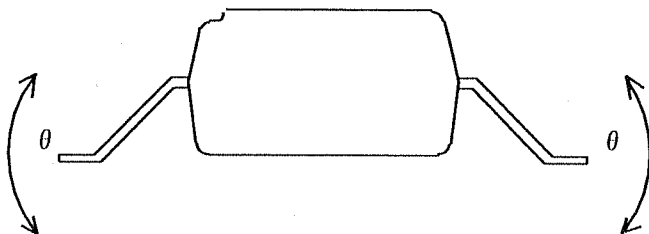

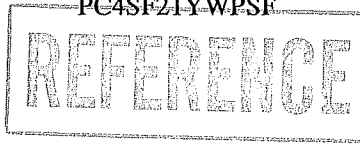

5. Outgoing inspection

5.1 Inspection items

(1) Electrical characteristics

V_F , I_R , I_{DRM} , V_T , I_{FT} , R_{ISO} , V_{ISO}

(2) Appearance

5.2 Sampling method and Inspection level

A single sampling plan, normal inspection level II based on ISO 2859 is applied.

The AQL according to the inspection items are shown below.

Defect	Inspection item	AQL (%)
Major defect	Electrical characteristics Unreadable marking	0.065
Minor defect	Appearance defect except the above mentioned.	0.25

6.2 Package specifications

6.2.1 Taping conditions

(1) Tape structure and Dimensions

The carrier tape has the heat pressed structure of PS material carries tape and three layers cover tape (PET material base).

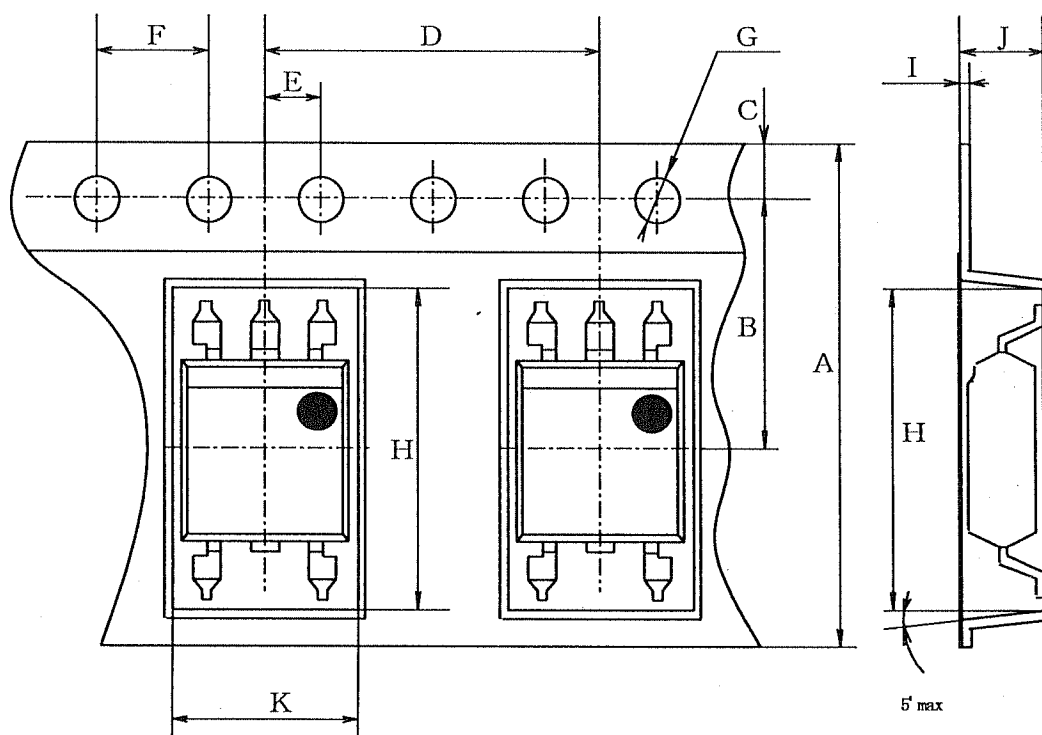

Dimensions list (Unit : mm)

A	B	C	D	E	F	G	H	I	J	K
±0.3	±0.1	±0.10	±0.1	±0.1	±0.1	+0.1 -0.0	±0.1	±0.05	±0.1	±0.1
24.0	11.5	1.75	12.0	2.0	4.0	φ 1.5	12.2	0.40	4.2	7.8

(2) Reel structure and Dimensions (Refer to the attached sheet, Page 11)

The taping reel shall be of plastic (PS material).

(3) Direction of product insertion (Refer to the attached sheet, Page 11)

(4) Joint of tape

The cover tape and carrier tape in one reel shall be jointless.

(5) To repair failure-taped devices, cutting a bottom of carrier tape with a cutter.

After replacing the cut portion shall be sealed with adhesive tape.

6.2.2 Adhesiveness of cover tape

• The exfoliation force between carrier tape and cover tape shall be 0.2N to 0.7N for the angle 160° to 180° .

6.2.3 Rolling method and quantity

• Wind the tape back on the reel so that the cover tape will be outside the tape.

Attach more than 20cm of blank tape to the trailer and the leader of the tape and fix the both ends with adhesive tape.

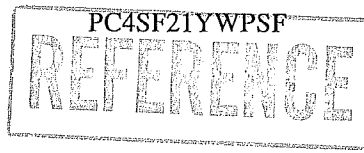

One reel basically shall contain 1000pcs.

6.2.4 Outer packing appearance (Refer to attached sheet, Page 12)





6.2.5 Marking

(1) Label of model No., Lot No. and quantity

S H A R P Electronic Components		NO CFCs used In this packaging MADE IN JAPAN
TYPE	4SF21 (PC4SF21YWPSF)	 
QUANTITY	1000	
LOT (DATE)	***** - **	
	S5	

- Label dimensions 60mm × 42mm
- Indications
 - 4SF21 Model No.
 - TYPE : (PC4SF21YWPSF) Business dealing name
 - QUANTITY : 1000 For cartons (1000)
 - LOT (DATE) : *****_** Packing lot No.
 - ** Mark date code

(2) Bar code label

MODEL NUMBER : PC4SF21YWPSF  QUANTITY : 1000  PRODUCTION DATE CODE : S5 
--

- Label dimensions 65mm × 45mm
- Bar coding method Code 39
- Indications
 - Model No. : PC4SF21YWPSF Business dealing name
 - QUANTITY : 1000 For cartons (1000)
 - Production date code : S5 Mark date code

6.2.6 Storage condition

- Taped products shall be stored at the temperature 5 to 30°C and the humidity less than 70%RH.
 Away from direct sunlight.

6.2.7 Safety protection during shipping

- There shall be no deformation of component or degradation of electrical characteristics due to shipping.



Reel structure and Dimensions

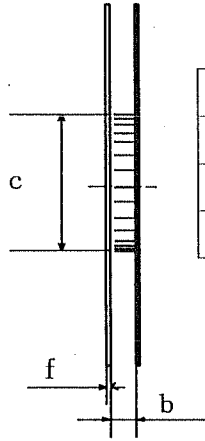
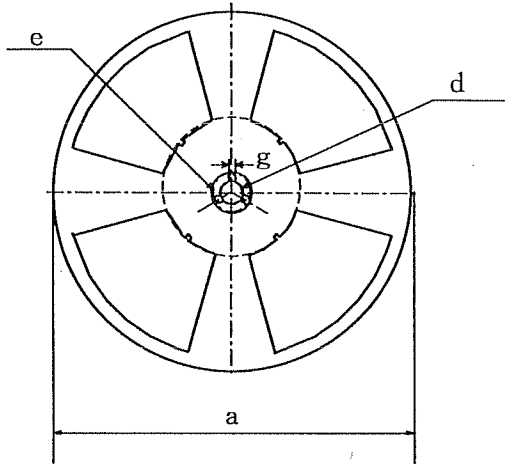

Dimensions list (Unit : mm)

a	b	c	d
330	25.5±1.5	100.0±1.0	13.0±0.5
e	f	g	
23.0±1.0	2.0±0.5	2.0±0.5	

Direction of product insertion

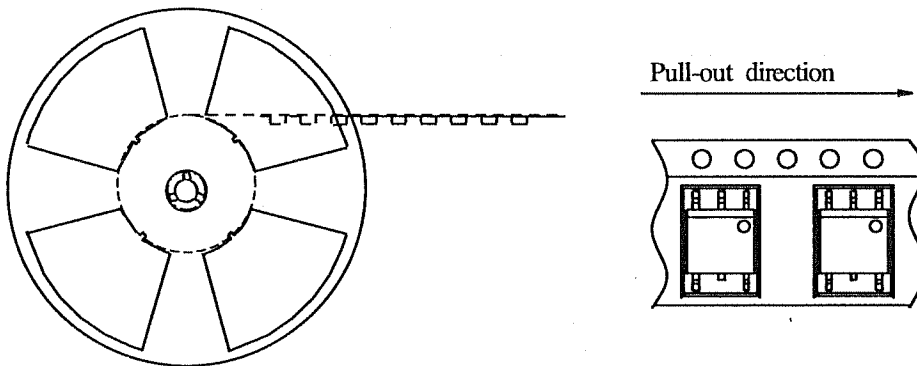

Taping reel indication

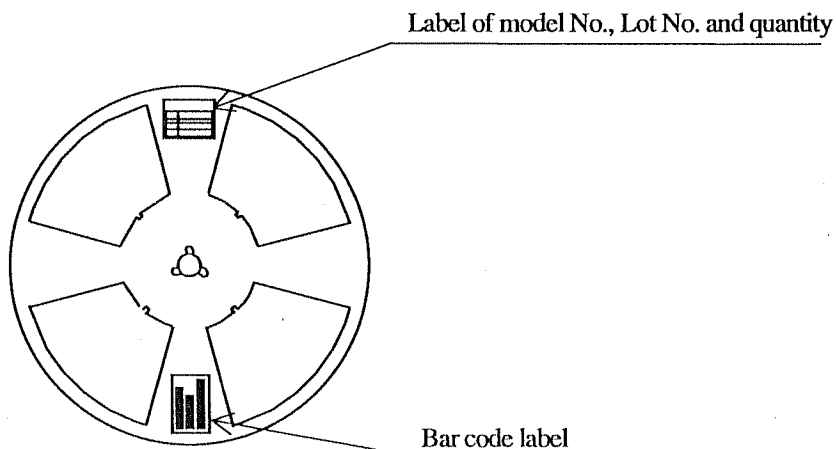



Packaging indication

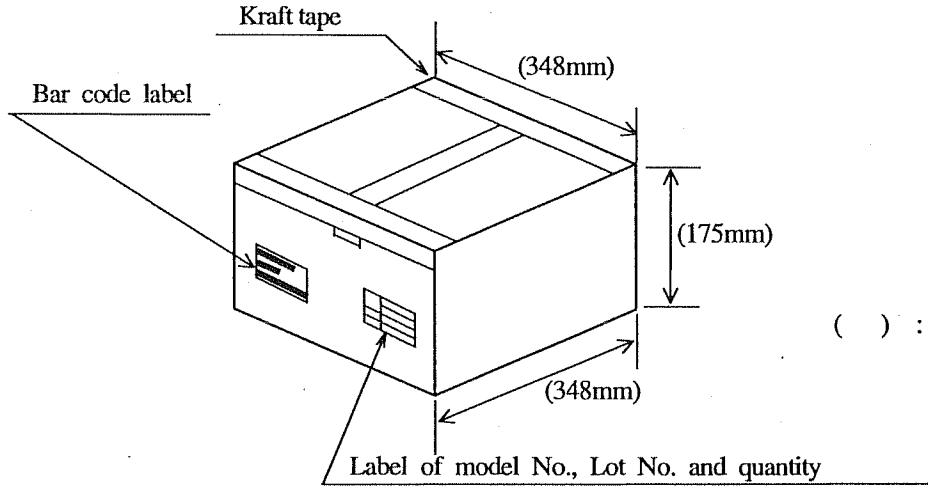

() : Reference dimensions

Outer packing appearance

